

# D412 / D412W / +MC1

## Roller Brake Tester



## USER MANUAL



## Copyright

Copyright © 2014 Boston Garage Equipment - All rights reserved worldwide.

All information contained in this document and any drawings, pictures, images and technical descriptions which have been made available by Boston, remain the property of the company and may not, **without written permission** from the company be used (except for the operation of equipment), duplicated in any way or made available to third parties.

## Disclaimer

Although every care has been taken during the preparation of this document, neither Boston or any other company involved in its production and / or equipment production shall be liable for any damages derived from the use of this documentation. Boston reserves the right to modify or improve its products and literature at any time without prior notification. Any or all pictures and images in this document are for demonstration purposes only.

This document may contain references to, or information about Boston products or services that are not yet available. These references or information in no way mean that Boston intends to make such products available.

This document may neither be partly or wholly duplicated, or distributed without prior authorisation from Boston. Requests for further copies of this document or further information should be addressed to an authorised agent, a Boston sales representative or to its e-mail address: [info@boston-ge.com](mailto:info@boston-ge.com).

Technical and sales documentation is available on our Internet website: <http://www.boston-ge.com>.

Boston may have patents or applications for patents in progress involving the matters described in this document. Supply of this document does not imply that any license to these has been granted.

## Contact Details

Boston Garage Equipment  
199 New Road  
Rainham  
Essex  
RM13 8SJ  
United Kingdom

Tel: +44 (0)1708 525585      Email: [info@boston-ge.com](mailto:info@boston-ge.com)  
Fax: +44 (0)1708 525408      Web: [www.boston-ge.com](http://www.boston-ge.com)

## Contents

<b>Chapter 1</b>	<b>Introduction</b>	<b>5</b>
	Audience	5
	Scope	5
	Organisation	6
	Layout Conventions	6
	Related Documents	7
<b>Chapter 2</b>	<b>Safety</b>	<b>8</b>
	General Safety Instructions	8
	Maintenance Safety	9
	Safety Features	9
	Misuse	9
<b>Chapter 3</b>	<b>Product Description</b>	<b>10</b>
	System Overview	10
	D412B Roller Bed	12
	MCU-090 (Master Control Unit)	14
	GCP (Global Control Platform)	16
	RFC-95 (RF Remote Control)	17
	MC1 (Motorcycle Testing Cover Plate)	19
<b>Chapter 4</b>	<b>General Operation</b>	<b>20</b>
	Power On (MCU-090)	20
	Power On (BPC-091)	21
	Menu Navigation	21
	Mouse Control	22
	Keyboard Control	23
	Software Version	24
<b>Chapter 5</b>	<b>Standard Brake Test</b>	<b>25</b>
	Vehicle Data Entry	26
	Display Layout	29
	Placing Vehicle in Rollers	31
	Vehicle Weight	32
	Testing Front Axle	33
	Testing for Imbalance	35
	Testing Rear Axle	37

## Contents

	Testing the Parking Brake	37
	Test Results and Printing	38
	Testing 3 Wheeled Vehicles (3WV)	41
	Testing Four Wheel Drive Vehicles (4WD)	42
	Testing Motorcycles	45
	Automated Brake Test	58
	Saving Test Results	67
<b>Chapter 6</b>	<b>Official Brake Tests</b>	<b>69</b>
	Official Tests - Data Entry	70
	Manual Tests – 2WD Vehicles	74
	Testing 3 Wheeled Vehicles (3WV)	79
	Testing Four Wheel Drive Vehicles (4WD)	79
	Testing Motorcycles	79
	Official Automated Brake Test (ATL)	80
<b>Chapter 7</b>	<b>DVSA Regulations UK</b>	<b>82</b>
	Brake Efficiency	82
	Brake Imbalance	82
	Efficiency Limits	83
	Motorcycle Limits	84
<b>Chapter 8</b>	<b>Troubleshooting and Maintenance</b>	<b>85</b>
<b>Chapter 9</b>	<b>Warranty / Guarantee</b>	<b>87</b>
<b>Chapter 10</b>	<b>Product Specifications</b>	<b>88</b>
	D412B Roller Bed Specification	88
	RF-90 RF Remote Control Specification	89
	BPC-091 Mini PC Specification	90
	MCU-090 Control Unit Specification	91
	CE Declaration	92

## In This Chapter

---

Audience	5
Scope	5
Organisation	6
Layout conventions	6
Related documents	7

### Audience

This manual is intended for the final users of the equipment who will operate and maintain the system throughout its working life.

Boston Garage Equipment requires that operators of this equipment:

- Have sufficient technical knowledge and experience to operate the equipment
- Can recognize and prevent potential hazards
- Have read and understood this manual
- Have been adequately trained
- Follow the procedure in this manual

### Scope

The purpose of this manual is to:

- Describe the operation of the system
- Describe its operating principles and general construction
- Explain safety features and safety precautions
- Highlight possible hazards
- Describe the operation procedures
- Describe the maintenance procedures
- Troubleshooting

## Organisation

This manual is organised into:

- Safety – Describes safety features of the system and safety precautions to follow when operating the system. Read this section before operation and maintenance.
- Functional Description – Contains a functional description of the system.
- Operating Instructions – Contains all the procedures necessary to operate the equipment safely.
- Troubleshooting and Maintenance – Contains procedures to solve problems encountered during operation and maintenance procedures that can be carried by the user.
- Parts List – Contains parts lists and drawings.

## Layout Conventions

In this manual we use a number of typographical conventions to highlight particularly important information and to guide the user through the manual. This section lists these conventions.

Two types of list are used.-

- 1) Lists that are numbered (like this sentence) contain actions you must carry out in sequence.
- In lists that use arrow points (like this sentence), the sequence is not critical.

---

### **NOTE**

*Text with additional information, such as expanded explanations, hints or reminders.*

---

### **CAUTION**

*Indicates situations that can be dangerous or cause damage.*

Commands (such as menu items and buttons) are **bold**. Menu names are also **bold**.

Example: On the remote control press **4**.

Information that requires special attention is shown in *italic*.

Example: Use the **Emergency Stop** button *only* in emergencies.

## Related Documents

Document Name	Document Number
➤ SW900 User Manual	BOS0320
➤ RFC-95 User Manual	BOS0423

## In This Chapter

---

General Safety Instructions	8
Maintenance Safety	9
Safety Features	9
Misuse	9

## General Safety Instructions

In order to comply with your responsibilities under the Health and Safety at Work Act 1974, it is essential that this Roller Brake Tester (RBT) and any optional accessories are sited, installed, operated, and maintained by Boston Garage Equipment or your local authorised / approved distributor.

- All persons installing, operating or maintaining the equipment and any optional accessories must be familiar with the layout of the equipment, the safety precautions, the emergency shutdown procedures and vehicle braking systems.
- Appropriate training is required, prior to installing, using or maintaining the equipment.
- The instructions in this manual must be strictly adhered to, to avoid injuries to personnel and damage to the machine and vehicle.
- Only a qualified technician should carry out work on the electrical system, and should follow procedures pre-described by national standards.
- Never remove or bypass any of the safety features.
- Avoid any direct or indirect electrical contact.
- The unit should be placed inside a rigid, flat and clean surface, protected against water, humidity and weather influences.
- Keep the operating environment clean and free of oil. Never leave loose objects around the RBT.
- Never leave parked vehicles on the RBT overnight.
- Make sure the remote control is stored safely when not in use.
- The equipment may be operated only within its rated capacity. The equipment is designed for MOT Class 1, 2, 3 & 4 vehicles.
- The equipment should only be used when the operator has a good view of the whole machine.
- During the test no person should stand close to the roller bed(s).
- The testing area should be clear of personnel, tools and equipment before starting each stage of the test.
- Do not stand on, or walk over the rollers at any time.
- Take precautions to extract exhaust in the workplace properly while testing.
- Do not test a vehicle when there is insufficient light.
- Never make any adjustments to the vehicle braking system when the vehicle is in the rollers.
- When the RBT rollers are in operation, any key on the remote control or PC keyboard will immediately stop the rollers, irrespective of their prescribed function.
- In case of an emergency, all operations can be stopped immediately by pressing the emergency stop button on the side of the control cabinet.
- If the RBT is not working correctly, switch off immediately and refer to the user manual or contact Boston or their local agent.
- Always isolate the RBT from the power supply before maintenance.
- Follow the maintenance specifications accurately.



## Maintenance Safety

In addition to the general safety instructions, the following instructions apply when carrying out maintenance on the equipment:

- Switch off the main electrical supply before opening any part of the equipment.
- The equipment must only be operated within its rated capacity.
- Protect the electrical parts of the equipment from water and humidity.
- Only qualified technicians are permitted to do work on the electrical system of the equipment and must follow procedures prescribed by national standards.
- Many safety features are bypassed inside the service areas of the software. Only qualified service personnel are permitted to use the service section of the software.
- Any unauthorised modification or changes to the system will invalidate the CE-declaration and equipment warranty.

## Safety Features

The D412 RBT offers the following standard safety features to minimise personal risk as much as possible.

- The RBT is provided with an emergency stop button on the side of the control cabinet by which any active operation can be stopped immediately in case of an emergency. To release the emergency stop button after operation, rotate the button.
- The rollers of the RBT's can only be started if the centre rotating measuring rollers are pressed down, i.e. when there is a vehicle axle in the roller brake tester (except when 3-wheel or motorcycle modes are selected).
- By applying brake force and locking any wheels under test, the rollers will stop immediately.
- Closed covers for the chain and electrical components are fitted as standard.
- All electrical cabling is covered to reduce any direct danger or risk.
- The RBT is ground wired to earth.
- Cover plates are provided to cover the rollers when the brake tester is not in use.
- Whenever the rollers of the RBT are in operation, any key press on the keyboard or remote control will immediately stop the rollers irrespective of the assigned key function.

## Misuse

The RBT is designed for use as a brake tester for statutory testing of MOT Class 1, 2, 3 & 4 vehicles and for brake diagnostic purposes **only**.

It must NOT be used for any other purpose e.g.

- 'Running in' of brake linings.
- Brake adjustments.
- Diagnosis of vehicle faults e.g., tyre examination etc.
- Any purpose requiring the operator to be in the danger zone, other than to conduct a brake test and/or maintenance and calibration purposes (authorised personnel only).
- If access to any service area requires driving over the RBT then cover plates must be used

## In This Chapter

System Overview	10
D412B Roller Bed	12
MCU-090 Multi Connection Unit	14
GCP Global Control Platform	16
RFC-95 RF Remote Control	17
MC1 Motorcycle Testing Cover Plate	20

## System Overview

The RBT is a well-known method for analysing the efficiency of the braking system of a vehicle.

There are several main components that comprise the D412 RBT, these are listed below and are covered in detail later on this chapter.

- D412B      The steel chassis floor module containing the rollers and all sensors.
- MCU-090    A wall mounted cabinet containing the cable connections from the roller bed, data acquisition circuitry and operation control relay cards.
- GCP        Boston's computer control system running the SW900 control software with mouse, keyboard LCD display monitor and laser printer.
- RFC-95    An RF Remote control for remote operation of the RBT from inside the vehicle.
- MC1        A small cover plate that attaches to the roller bed to enable the safe testing of smaller motorcycle wheels.

The mechanical floor unit contains two electrical motors, two independent sets of three measuring rollers, two brake force transducers, additional safety sensors and an optional four point vehicle weighing system fitted to the base or installation cartridge.

During testing, the brake forces induce reaction forces on the electric motor which in turn applies force to an electric transducer with strain gauges. Through software, the sensors are monitored and the data collected is converted into a reading and displayed on a monitor for the operator to see. The rotating brake rollers are coated with a wear-resistant material which provides high friction values in both wet and dry conditions. The roller diameters are sufficiently large to keep the tyre flexing to a minimum.

The third smaller roller on each side between the wheel supporting rollers has two functions:

- The first is to detect if a vehicle is present in the roller bed (a built in safety device to prevent the motor starting without a vehicle in place). For safety purposes, the motors will **not start** if both the left and right small rollers are not pushed down for more than two seconds (except when 3-wheel mode or motorcycle mode is selected).
- The second function is to detect if tyre slip on the rollers does not exceed the maximum value.

The GCP control system can be configured in two ways, either wall mounted or fitted into a mobile trolley / cabinet stand. The GCP that controls the RBT is not connected directly to the roller bed but to the MCU (Master Control Unit) via USB.

The MCU is a wall mounted connection panel which the mechanical floor unit is wired to. It contains the various components to acquire data from the sensors during braking and control relays for starting and stopping the rollers. It has an emergency stop button and main power switch located on one side of the panel.

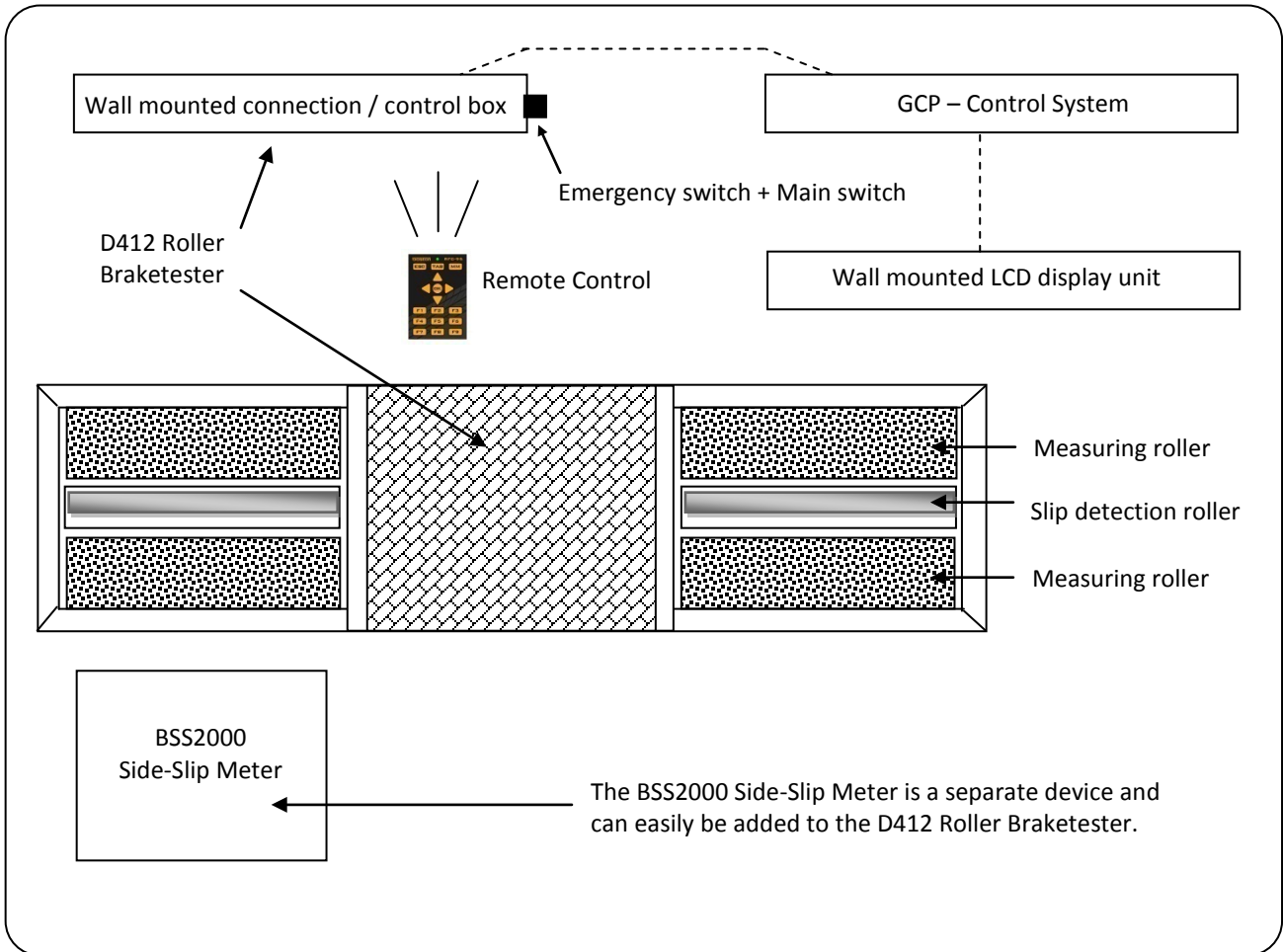

## D412B Roller Bed

The D412B Roller Bed is a single chassis unit containing four high friction surface rollers and two smaller free rolling rollers to detect wheel presence and measure wheel speed. The unit is equipped with two brake force measurement sensors and can be fitted with an optional vehicle weighing system.

A general layout of the D412B Roller Bed is shown below.-

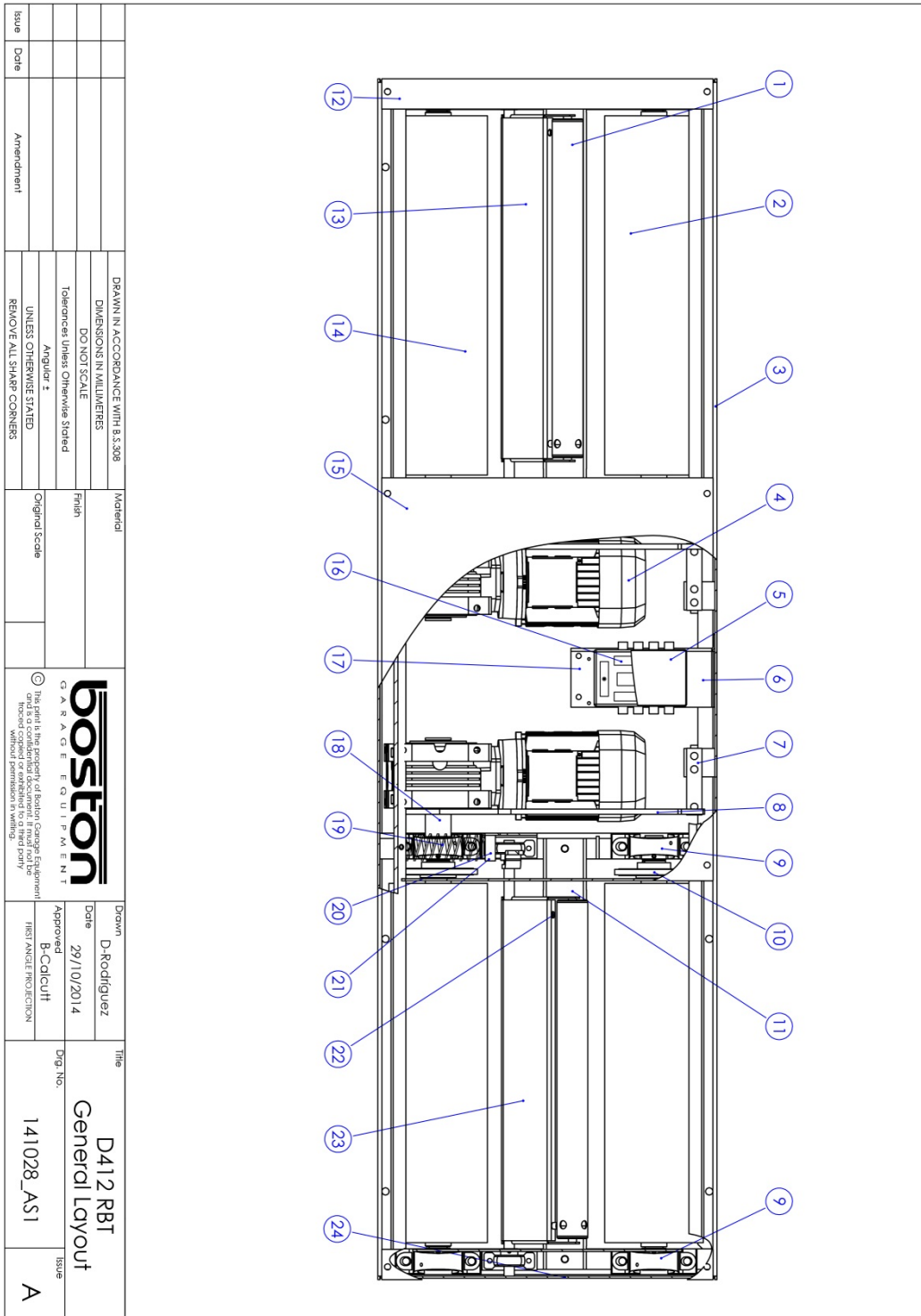

## Component Table

<b>Item</b>	<b>Description</b>	<b>Quantity</b>
1	Tacho roller	2
2	Front roller	2
3	Chassis	1
4	Motor 230/400V 3kW	2
5	Connection PCB Enclosure	1
6	Connection Box Support Bracket	1
7	Force Transducer	2
8	Torque Arm	2
9	Bearing Housing	4
10	Chain Roller	4
11	Protection Plate	2
12	Side Covers	2
13	Detection Frame LEFT	1
14	Rear Roller	2
15	Centre Cover Plate	1
16	Connection PCB	1
17	Ground Connector	1
18	Drive Shaft Spacer	2
19	Spring Extension	2
20	Tacho Stop Block	2
21	Rubber Stop	2
22	Proximity Switch	2
23	Detection Frame RIGHT	1
24	End Chassis	2

## MCU-090 (Master Control Unit)

The MCU-090 is an interface / connection box where the power cables for the motors and data cables for the sensors are all connected. Although the MCU-090 is used for the control of the D412B roller bed, it can also be used to connect and control the following components to provide a full test lane.-

- R102                      Class 1,2 Motorcycle Roller Brake Tester
- R103                      Class 1,2 Motorcycle Roller Brake Tester
- D402 / D402W+MC1    Class 1,2,3,4 Roller Brake Tester (Manual and Auto Testing)
- D412 / D412W+MC1    Class 1,2,3,4 Roller Brake Tester (Manual and Auto Testing)
- D403 / D403+MC2      Class 1,2,3,4 Roller Brake Tester (Manual and Auto Testing)
- D702 / D702+MC3      Class 1,2,3,4,5L,7 Roller Brake Tester (Manual and Auto Testing)
- D712 / D712+MC3      Class 1,2,3,4,5L,7 Roller Brake Tester (Manual and Auto Testing)
- S402                      3T Suspension Tester
- S702                      4T Suspension Tester
- SS02                      4T Side-Slip Meter
- AGS200                  Exhaust Gas Analyser
- AGS688                  Exhaust Gas Analyser
- OPA100                  Exhaust Diesel Smokemeter
- B502                      Electronic Headlight Tester

---

### NOTE

*Some items listed above may be under development.*

---

In most cases the MCU-090 will be supplied in standard configuration. This will allow control of the majority of products above (and some others) simultaneously. Depending on specific customer requirements, additional internal components may be required.



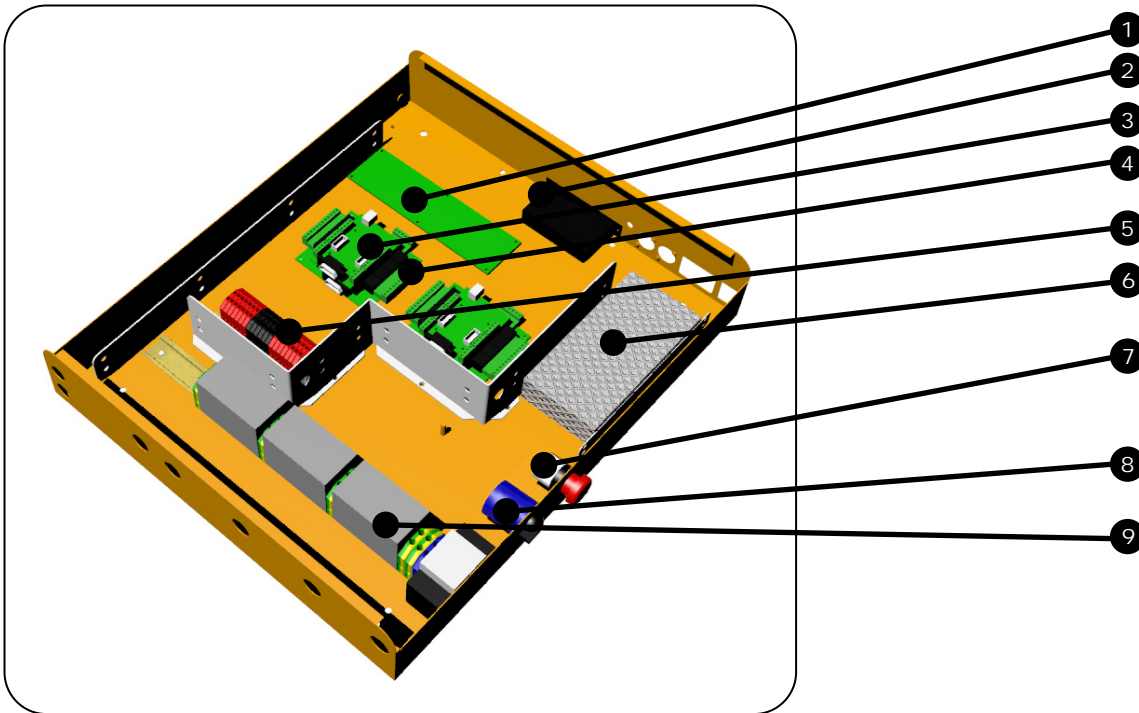

The MCU-090 is connected to the GCP using a standard USB A-B connection cable. Older versions of Boston Control Platforms may also be used to control the MCU-090, check with your local distributor for compatibility.

---

**NOTE**

*There are no user serviceable parts inside the MCU-090 and all maintenance / repairs should be carried out by approved Boston engineers.*

---

**Component Table**

Item	Description
1	Connection Interface Card
2	Powered USB Hub
3	Data Acquisition Card 1 (Optional second card can be installed)
4	Relay Card 1 (Optional second card can be installed)
5	Low Voltage Connection Din Rail
6	Power Supply
7	Emergency Stop Button
8	Main Power Switch
9	High Voltage Relay Din Rail

## GCP (Global Control Platform)

The GCP is the computer control station that connects to the MCU-090 via USB. It is a separate unit and can be supplied in different configurations, but in most cases it is wall mounted with a display monitor and mouse / keyboard (GCP1). A breakdown of the GCP main standard supply components is listed below.-

- Mini Industrial PC with Windows OS and Internal Wifi
- Boston Software SW900
- Optical PC Mouse
- PC Keyboard
- Widescreen LED Monitor
- Laser Printer
- Wall mount bracket or rolling stand

The GCP can also be supplied as a mobile unit using one of Boston's rolling cabinet stands.

- GCP3 - Circular Drum-Type Mobile Stand (as shown below)
- GCP2 - Standard Mobile Stand

In all cases, the GCP can also be fitted with a second display monitor up to 60" in size. Please contact Boston or your local sales / service agent for further information.

This manual only covers the Braketester software program; another manual is available separately detailing the operation and functions of the SW900 software installed on the GCP.





## RFC-95 (RF Remote Control)

The remote control is the most commonly used control for the SW900 software. It has many of the same functions as the keyboard but from a wireless range of approximately 50m. There is a separate User Manual available for the Boston RF Remote Control, but the main functions are covered here.

Many remote controls operate using infra-red (IR) technology. Whilst being reliable, they are restricted to 'line-of-sight' operation which in some environments can make them impractical. The Boston RFC-95 is a ruggedized control, ideally suited for the testing industry where rugged protection is required. It operates using the latest Zigbee Radio Frequency (RF), which unlike IR doesn't require line of sight operation. This provides greater flexibility and allows it to be used from inside the vehicle to control different items of equipment.

The RFC-95 button functions are shown below.



**'TAB' Key**

This button duplicates the 'Tab' key function on the main keyboard.

**Transmission LED**

The LED illuminates to confirm any key press.

**'MM' Button**

This button returns the operator to the Main Menu (only for Boston SW-900 software).

**'ESC' Button**

This button duplicates the 'ESC' key function on the main keyboard.

**Arrow Keys**

These buttons duplicate the arrow key functions on the main keyboard.

**'OK' Key**

This button duplicates the 'ENTER' key function on the main keyboard.

**'F' Keys**

These buttons duplicate the 'F' key functions on the main keyboard.



Button	Associated keyboard Function
ESC	ESCAPE
TAB	TAB
MM	MAIN MENU (SW900 Software only)
ARROW UP	ARROW UP
ARROW DOWN	ARROW DOWN
ARROW LEFT	ARROW LEFT
ARROW RIGHT	ARROW RIGHT
OK	ENTER
F1	FUNCTION KEY F1
F2	FUNCTION KEY F2
F3	FUNCTION KEY F3
F4	FUNCTION KEY F4
F5	FUNCTION KEY F5
F6	FUNCTION KEY F6
F7	FUNCTION KEY F7
F8	FUNCTION KEY F8
F9	FUNCTION KEY F9

## MC1 (Motorcycle Testing Cover Plate)

In order to test motorcycles, it is necessary to fit the MC1 cover plate to the required testing roller. The cover plate is designed specifically to accommodate motorcycle wheels and safely cover the unused open portion of the rollers. The cover plate is attached to the roller bed using two bolts and can be fitted very quickly. It contains two hinges allowing the plate to 'swing' into place without the need to permanently remove from the roller bed.

To fit the cover plate, refer to the illustration below.-

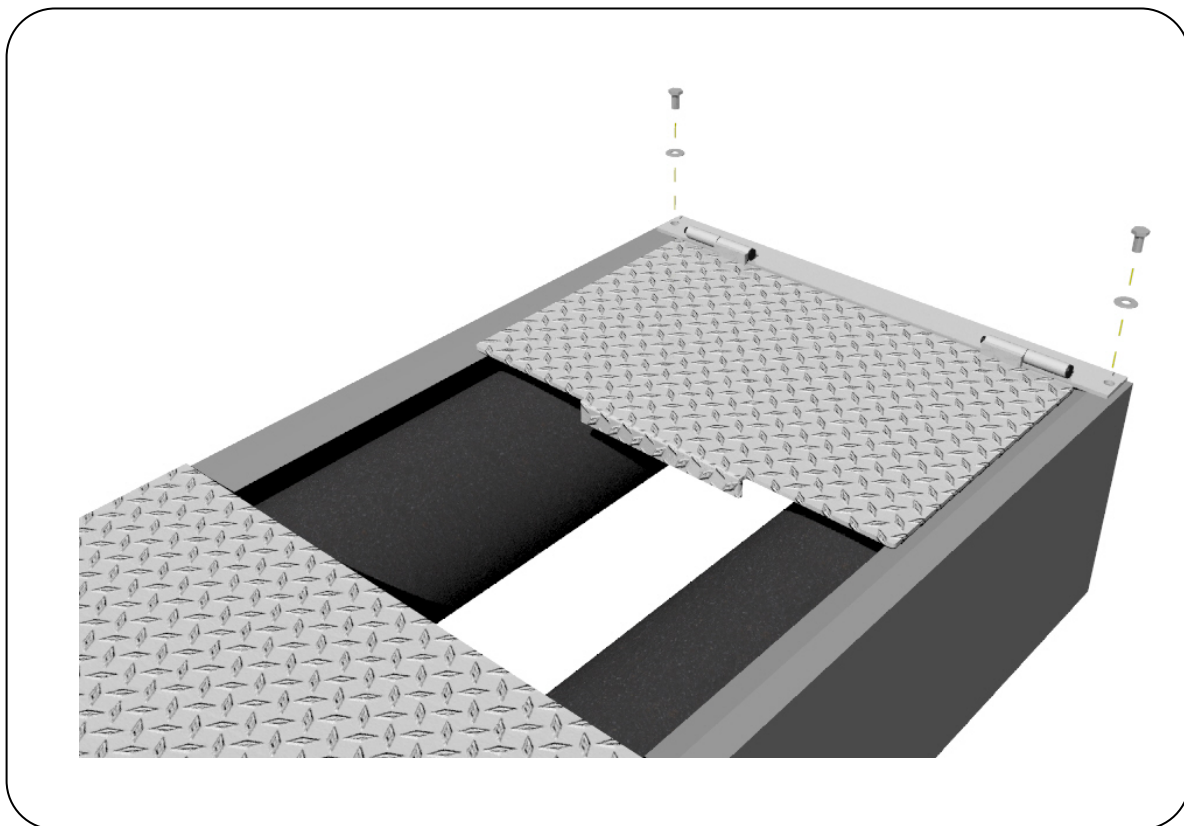

---

### **NOTE**

*The MC1 is a foot plate and is not intended for vehicles to drive over.*

---

### **CAUTION**

*Motorcycle testing can only be carried out when the MC1 cover plate adapter has been fitted. The plate limits the width of the open roller surface to accommodate the narrow wheels of motorcycles. It is dangerous and prohibited to test motorcycles without the MC1 cover plate fitted.*

### In This Chapter

---

Power On (MCU-090)	20
Power On (BPC-091)	21
Menu Navigation	21
Mouse Control	22
Keyboard Control	23
Software Version	24

### Power On (MCU-090)

The MCU-090 has a Main Power switch and Emergency Stop button on the side of the cabinet. The Main Power switch interrupts and isolates the power to the GCP control system and any other connected equipment. The Emergency Stop button immediately stops all current operations and turns off the control side of the system. It is usually left in the 'running' state and only used in the event of an emergency. The operation of both these switches is shown below.-



<b>MAIN POWER SWITCH</b>	-	Isolates power from the entire system and all other connected equipment.
<b>OPERATION</b>	-	Rotate switch in clockwise / anti-clockwise direction.

---

<b>EMERGENCY STOP</b>	-	Immediately stops all operations and turns off power to the control side of the system.
<b>OPERATION</b>	-	Press switch to activate. Rotate clockwise to deactivate.

Once power is applied to the MCU-090 the system is ready and waiting for instructions from the PC control platform.

---

#### NOTE

*In the wall-mount configuration, the power for the PC, monitor and printer is taken from the MCU-090. When switching off the **main** power as described above, remember these items will also be switched off.*

---

## Power On (BPC-091)

When power is applied to the BPC-091 PC, the system will automatically start-up and enter into the main software menu page (as shown in the screenshot below). This will happen in the event of a power-cut or even if the unit has been previously powered down and the power source removed and restored. In all cases, when power is detected that was previously not present the system will auto-start.

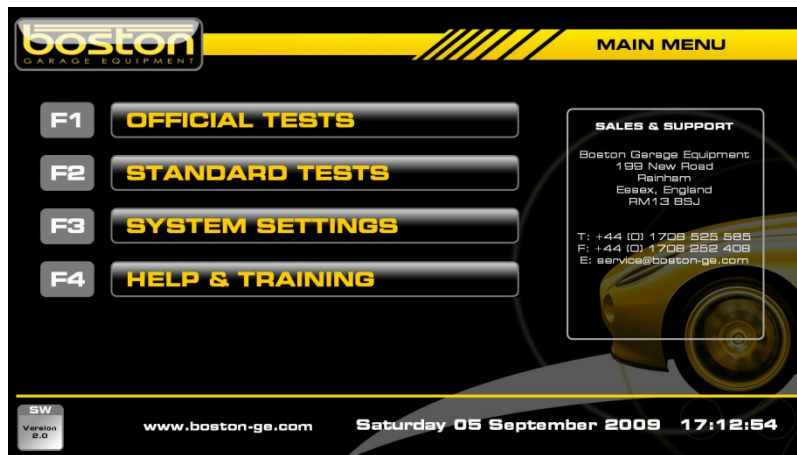

There are also two power buttons on the right side of the PC. These are the main 'POWER' button and the 'RESET' button. A single press of either will perform the following function:-



POWER Button - Powers down the system. To restart, press the POWER button again.



RESET Button - Resets the system by powering down and then re-starting automatically.

## Menu Navigation

After initial power-on, the page shown above should be displayed. From this page the user can select whether to perform tests (options F1 and F2) or to change settings (F3) or seek assistance (F4). All options in the SW900 software are described in detail in the SW900 User Manual available separately. For the purpose of this manual we shall only cover the operation of the RBT program.

The software can be operated in several ways, either by using the keyboard, the mouse or the remote control. All three options are available to the user (depending on their preference) and can be used at any time, and anywhere within the software.

As the user scrolls through each menu option, it becomes highlighted to indicate the current selection. To select the highlighted option press the ENTER key on the keyboard. See screenshot below.



---

**NOTE**

When using the 'F' keys directly, the options are not highlighted but the software continues immediately to the selected option.

---

## Mouse Control

As the mouse pointer is placed on any of the different options, the option becomes highlighted in the same way as if the keyboard arrows keys or TAB key were being used. As the mouse pointer leaves the option the highlight is removed. To select any option, place the pointer over the desired option and click the LEFT button on the mouse. The software will proceed to the selected option.

Click the **LEFT** button on the mouse to make the selection.



## Keyboard Control

The software can be operated from the keyboard in several ways.

- By using the ↑ and ↓ ARROW keys to highlight and scroll through the menu options.
- By using the TAB key to jump to and highlight the next menu option.
- By using the 'F' keys along the top of the keyboard to directly select the required option.

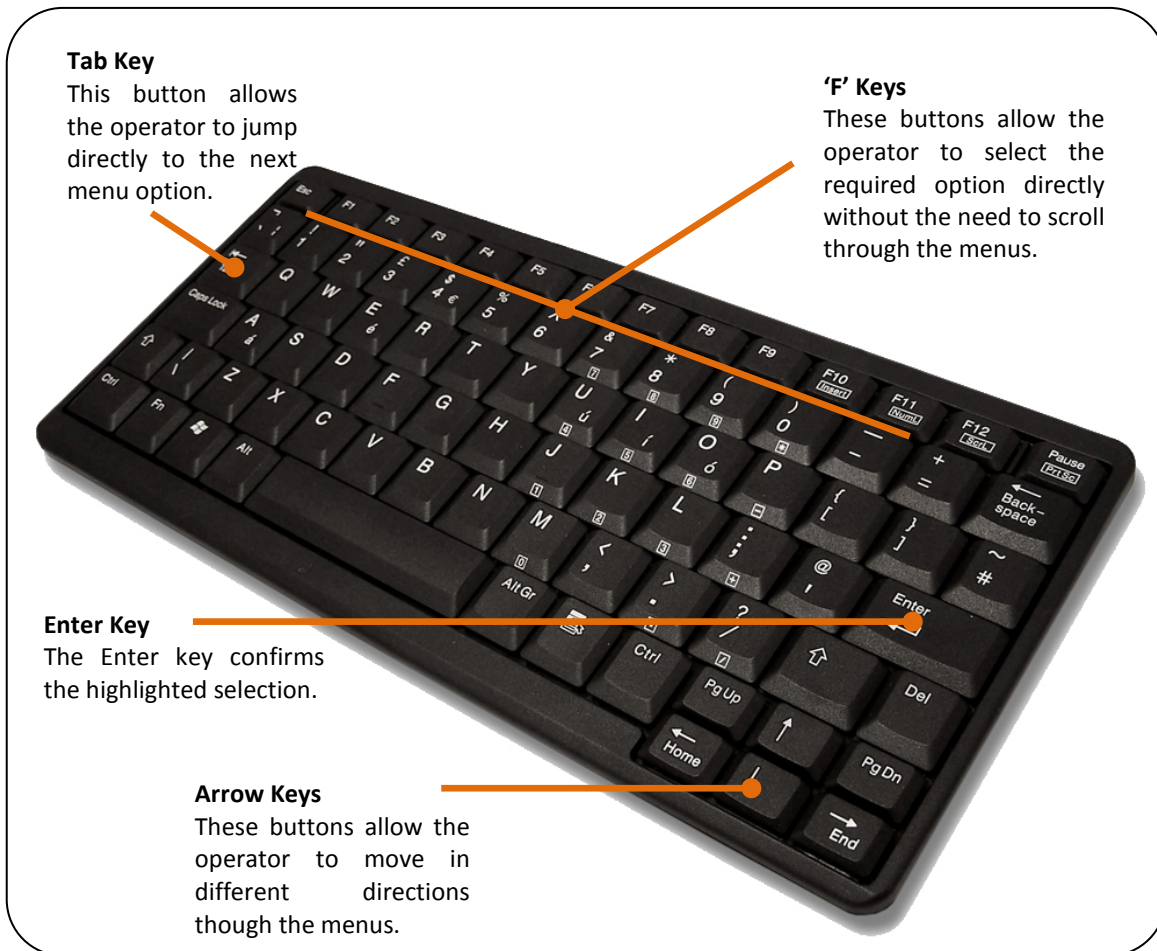

## Software Version

As new products become available and changes and additions are made to the various software procedures, the SW900 software will require updating. To easily find out which software version is currently being used, simply look at the bottom left-hand corner of any of the MAIN MENU pages.

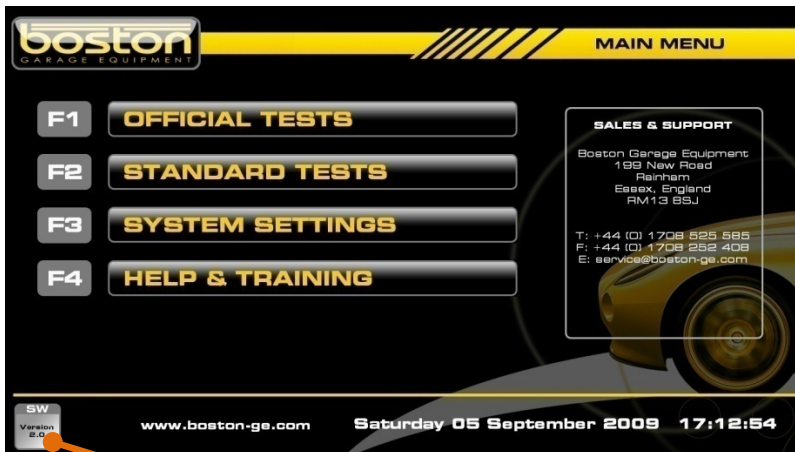

The current software version is shown here

By clicking on the button with the mouse, a pop-up window will be shown detailing the software version and changes made in the current version since the previous version. See below.

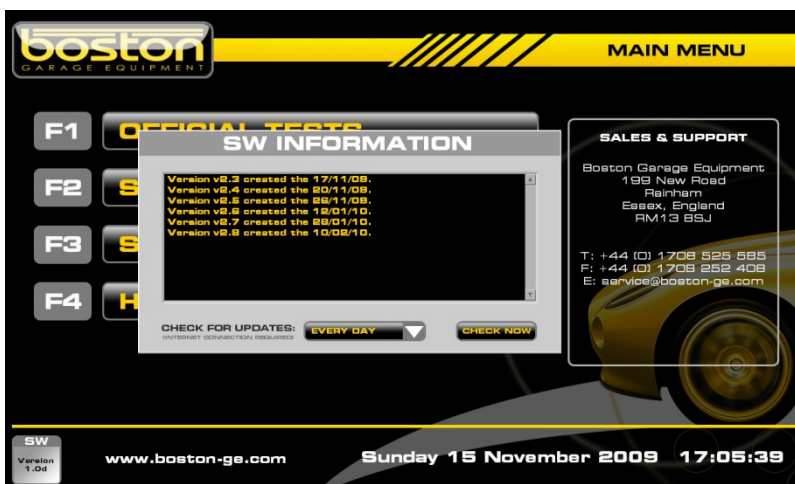

Software Updates are released periodically throughout the year and it is important that your software is up to date. Updates can be installed automatically if your system is connected to the internet. If not, your local agent can install updates on request.

Please see the SW900 USER MANUAL for further information about updating software.



### In This Chapter

---

Vehicle Data Entry	26
Display Layout	29
Placing Vehicle in Rollers	31
Vehicle Weight	32
Testing Front Axle	33
Testing for Imbalance	35
Testing Rear Axle	37
Testing the Parking Brake	37
Test Results and Printout	38
Testing 3WD Vehicles	41
Testing 4WD Vehicles	42
Testing Motorcycles	45
Automated Brake Test	58
Saving Test Results	67

This chapter describes how to carry out a STANDARD brake test using both the MANUAL and AUTOMATED software procedures. The STANDARD TEST option should be used for quick unofficial testing, and the OFFICIAL TESTS option for official tests. This manual assumes that installation of the RBT is complete and the software is fully enabled for the user. This manual also assumes that the user is familiar with the SW900 software and has read the SW900 software manual.

Before continuing, it is important to note and check the following:

- Brake forces are indicated in kgf.
- Weight input is indicated in kg.
- Imbalance is indicated in %.
- Brake efficiency is indicated in %.
- Examine the tyres to ensure they are not under-inflated, if the tyre pattern is in good condition and if the tyres are free from mud and stones.
- Determine whether the vehicle has a single brake control system or a split (dual) brake control system.
- Ensure the roller covers are removed from the RBT.
- Ensure the wheels of the vehicle are always placed centrally in the rollers before starting the test.
- Understand the quick stop emergency procedures should they be required.

---

#### **NOTE**

All references on the software pages to the 'F' keys on the keyboard also relate to the same function keys on the RF remote control. The following procedures do not relate to the remote control although the functions of the keyboard and remote control are the same.

---

The STANDARD BRAKE TEST is usually performed in the following order, but the software is able to accommodate any other order if preferred by the tester.

1. Service Brake - Front LEFT wheel
2. Service Brake - Front RIGHT wheel
3. Service Brake - Imbalance between both front wheels
  
4. Service Brake - Rear LEFT wheel
5. Service Brake - Rear RIGHT wheel
6. Service Brake - Imbalance between both rear wheels
  
7. Parking Brake - Rear LEFT wheel
8. Parking Brake - Rear RIGHT wheel

In some cases, the PARKING BRAKE may act on the front wheels, and it may be necessary to test the PARKING BRAKE with the front wheels still in the rollers. The list above is just an example of the most common type of test procedure and is the procedure demonstrated in this manual.

## Vehicle Data Entry

From the MAIN MENU, select option F2 'STANDARD TESTS' and follow the procedure below to reach the DATA ENTRY page.



F2 – STANDARD TESTS

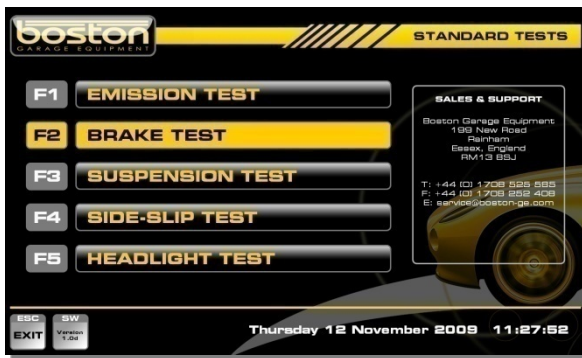

From this page the user selects the type of test required. If the relevant hardware and software is installed the software will continue into the respective program, if not, the message 'ACTIVATION REQUIRED' is shown. Similarly, if no tester's names have been set, the message 'SET TESTERS NAMES' will be shown.

F2 – BRAKE TEST



Whenever the DATA ENTRY page is entered, the message AUTO-ZERO will be shown briefly in the NOTIFICATION box. Whichever item of equipment has been selected from the test selection menu will be 'zeroed' prior to carrying out the test. At this point, it is important that the roller bed is clear and the roller covers are removed. If not, the software will 'zero' the system with an inaccurate measurement.

The DATA ENTRY page allows the user to enter specific vehicle data for the vehicle about to be tested. As the software is able to test different types of vehicles, it is important to ensure that the data is correct before selecting continue. The available types of test for MANUAL and AUTOMATED are shown below.

MANUAL TEST OPTIONS	AUTOMATED TEST OPTIONS
Motorcycle Test	2 Wheel Drive Vehicle Test
2 Wheel Drive Vehicle Test	
3 Wheeled Vehicle Test	
4 Wheel Drive Test	

Using the mouse and keyboard, enter the relevant information into the DATA ENTRY page. If the operator does not wish to enter vehicle data, the software will still allow the user to continue, but the missing information will not be shown on the printout if required.

**NOTE**

It is not compulsory for the user to enter any vehicle specific data, but the **VEHICLE TYPE** and **TEST TYPE** entry fields must be completed to allow the software to follow the correct route. The default settings for this page are: **2 WHEEL DRIVE, MANUAL and CLASS IV**. The display layout can also be set by selecting F1.



**STANDARD - DATA ENTRY**

TESTERS NAME: **BRAD**

VEHICLE TYPE: **2 WHEEL DRIVE**

TEST TYPE: **MANUAL** **CLASS IV**

VEHICLE REG.: **E057 BNA** YEAR: **2007**

VEHICLE MAKE: **BMW**

VEHICLE MODEL: **335D**

MILEAGE: **12000**

ENGINE SIZE: **3000 cc**

**F2 CONTINUE**

ESC EXIT F1 F2

NOTIFICATION **CONTINUE**

### Test Selection Criteria

- If the user selects MOTORCYCLE from the VEHICLE TYPE pull-down menu, the TEST TYPE will automatically be set to MANUAL, CLASS 2.
- If the user selects 4 WHEEL DRIVE as the vehicle type, the TEST TYPE is automatically set to MANUAL. The option for AUTOMATED is not available.
- If the user selects 3 WHEELED VEHICLE as the vehicle type, the TEST TYPE is automatically set to MANUAL, CLASS 3 (CLASS 4 can still be selected by the user). The option for AUTOMATED is not available.
- If the RBT is fitted with a vehicle weighing system the WEIGHT box is not shown.
- The default settings for the DATA ENTRY PAGE are 2 WHEEL VEHICLE, MANUAL and CLASS IV.
- The YEAR field is completed automatically by the software depending on the registration of the vehicle. Eg. If the registration of the vehicle is E057 then the year is set to 2007. Although this field is set initially, it can also be edited by the user in the event that the year cannot be ascertained from the registration number (vehicles with old or personalised number plates).
- The data entry on this page is not compulsory and the user can save time by simply selecting CONTINUE, however, information not entered will not be shown on the printout if required.
- The pull-down menus on this page can be operated using the PC mouse, the TAB / ARROW keys on the keyboard or the remote control.

### **NOTE**

*Some of the options mentioned above may not be available. For example, MOTORCYCLE. This option will only be shown in the pull down list if the product has been purchased and installed.*

## Display Layout

From the DATA ENTRY page, it is also possible for the user to select the preferred display layout. There are three test layouts available as shown in the screenshots below.



To select a preferred layout, select F1 from the DATA ENTRY page as below.



From this page the user selects F1 – CHANGE DISPLAY. The following page is shown where the user can select any of three preferred layouts.

↓ F1 – CHANGE DISPLAY



Using the mouse, keyboard or remote control, select F1, F2 or F3 to choose a layout. The chosen layout will be shown on the first measurement screen after the vehicle has been placed in the rollers.

**NOTE**

For the purpose of this manual, the brake test procedures will be described using the analogue needle layout where applicable.

At any time during testing the user can change the display to a different layout by selecting F5.

At the bottom of the display there are a number of function buttons which are used to control and navigate the software. The buttons are sometimes different for each page depending on the functions available for the specific page. For the STANDARD TEST brake test screens, the buttons remain the same irrespective of the layout chosen by the user. The function of each button is also shown in the NOTIFICATION box when the user places the mouse over the button.

A layout of the buttons and their respective functions is shown below.



Button	Function
ESC	ESCAPE back to previous page
F1	Start LEFT roller
F2	Start BOTH rollers
F3	Start RIGHT roller
F4	Assign test results to memory
F5	Change display layout
F6	Show results page

To the right of the function buttons there is a NOTIFICATION BOX. Instructions and messages are shown in the box for the user to follow. The example below shows the text ROLLER STARTING to alert the user.



## Placing Vehicle in Rollers

Once the DATA ENTRY page has been completed and the preferred display layout has been selected, select **F2** to continue. The software will now ask the user to PLACE VEHICLE IN ROLLERS, see screenshots below.



At this point the software is waiting for the first axle to be placed in the rollers. The two grey circles indicated as 'L' and 'R' will turn green when the respective detection roller has been depressed by the wheel.

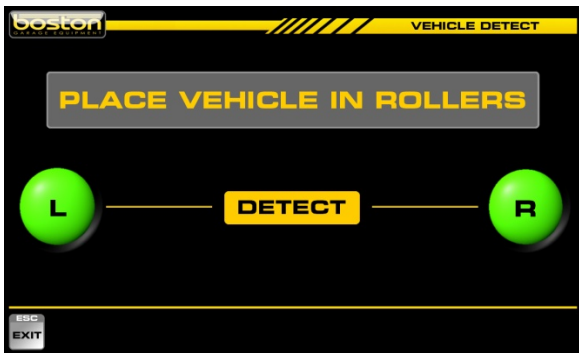

Both wheels have been placed in the rollers as shown by the two green indicators. This page is shown only for a few seconds before the software moves on to the vehicle testing page.

Once the rollers have been depressed, the detect indicators turn green and the software enters into the vehicle testing page. From this point onwards the testing procedures may differ depending on the vehicle details entered on the DATA ENTRY page.

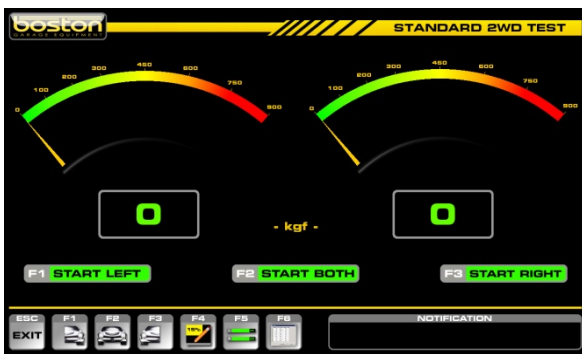

## Vehicle Weight

The SW900 control software automatically detects if a weighing system has been fitted to the D412B Roller Bed. If so, the WEIGHT box on the DATA ENTRY page is not shown. If the system is **not** fitted with a weighing facility then the operator should enter the total vehicle weight in the WEIGHT box on the DATA ENTRY page. Although this is not compulsory, it is required if the user wishes the software to make the overall brake efficiency calculations.



The total vehicle weight should be entered here if the **weighing system is not fitted** to the roller bed.

The software will acquire the axle weight automatically when the user starts either roller for the first time for each axle. The message ACQUIRING AXLE WEIGHT is shown while the system checks for a stable weight. The acquired axle weight is shown shortly after. See screenshots below in sequence. Once the weight has been acquired the software reverts back to the testing page and the selected roller(s) will start. There is an audible warning and warning text in red to alert the user.



From the testing page select F1, F2 or F3 to start the rollers. The software will automatically acquire the axle weight.

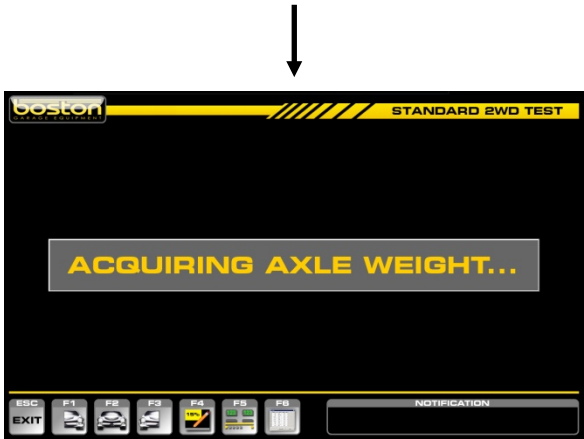



## Testing Front Axle

After the axle weight has been acquired the operator is warned by on-screen prompts in red and an audible buzzer that the rollers are about to start. See below.

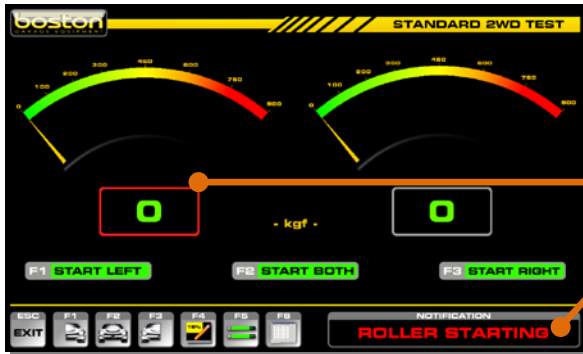

In this example, the left roller has been selected. There is an audible buzzer and three flashes of the red box to alert the user. The message 'ROLLER STARTING' is also shown in the notification box.

### NOTE

Whenever the rollers are running, the corresponding results box is shown in red. This applies to all screen layouts.

In order to quickly describe the front axle test, the test procedure below is shown in sequential list format with simple graphical illustration.

1. Place the front wheels in the rollers as instructed by the software.
2. Select 'F1 - START LEFT'. The software will first carry out the automatic weighing of the axle, then an audible alarm will sound and the roller will start. The outer box on the active roller will also flash red to indicate that the roller is running.

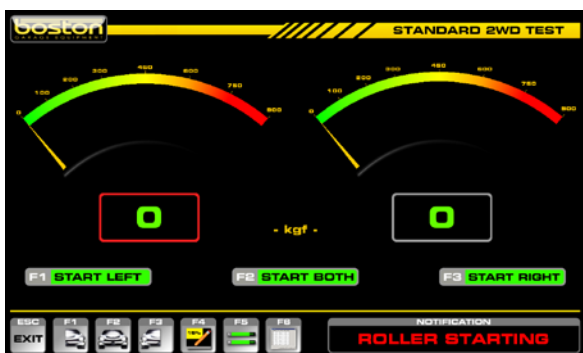

The user selects F1 and the rollers are about to start

3. **Slowly apply** force to the brake pedal and observe the real-time reading increase on the display.



Left roller is running and brake force is being slowly applied.

4. Continue to apply brake force until maximum force or wheel-lock is achieved. If wheel-lock occurs a red indicator will be shown on the display. At the point where the tyre slips on the roller the motor will be stopped immediately to avoid unnecessary tyre wear.



Left roller has stopped due to wheel lock. The wheel-lock indicator is shown above the corresponding reading. The highest brake force reading achieved is shown in the results box.

5. If wheel-lock cannot be reached while maximum brake force is being applied the rollers can be stopped by pressing the F1 key again (or any other key).



Left roller stopped by the user using the remote control or keyboard. The wheel-lock indicator is not shown but the highest brake force reading achieved is shown in the results box.

**NOTE**

Whichever means of stopping the rollers was used, the display will show the highest brake force achieved in the left hand display. The needle pointer will also indicate the same value on the analogue dial.

- Now that the result has been obtained for the LEFT wheel, carry out the same procedure for the RIGHT wheel using the F3 key to start the roller.

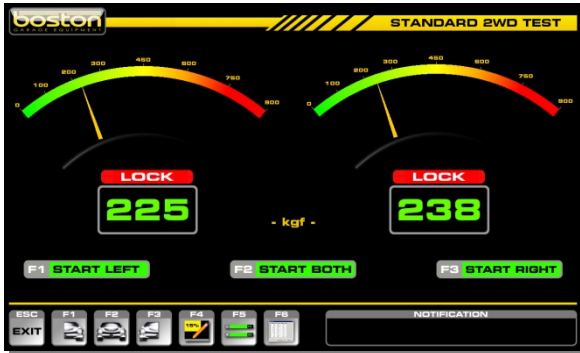

Even though the RIGHT wheel was tested, the result for the LEFT wheel still remains shown for comparison. The right wheel result is shown in the corresponding result box.

**Testing for Imbalance**

- Now that the service brake has been tested for both front wheels, the brake imbalance must be checked between them. To do this, both rollers are started together and the difference in brake force between the two wheels is measured as the brake effort is applied. Select F2 – START BOTH. The screen design changes slightly to show a single analogue scale. Without applying the brakes, note if any significant brake force (rolling resistance) is recorded from any wheel.

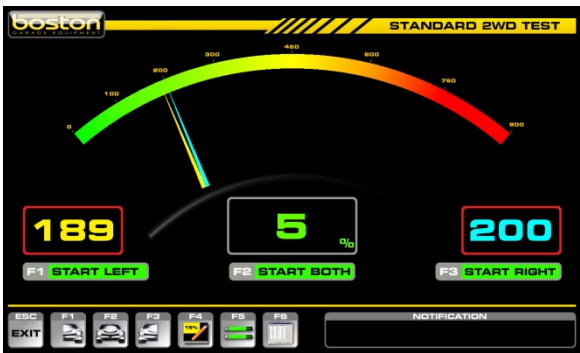

The rollers have started and brake effort is gradually applied. Both readings for LEFT and RIGHT can be seen together in both digital and analogue format using two different colour needle pointers. This gives a good indication of severe imbalance if present.

This test **does not** require the user to apply maximum brake effort to the pedal. Instead, the user should aim to stop just short of the maximum value achieved during the individual left and right wheel brake force measurement and then slowly reduce brake effort to a minimum. The software will automatically stop the rollers when either reading falls below 35kgf.

#### NOTE

The software disregards any service brake imbalance when the brake effort from each of the front wheels is less than 40kgf. The software will show the brake imbalance when brake effort from one wheel is greater than 40kgf.

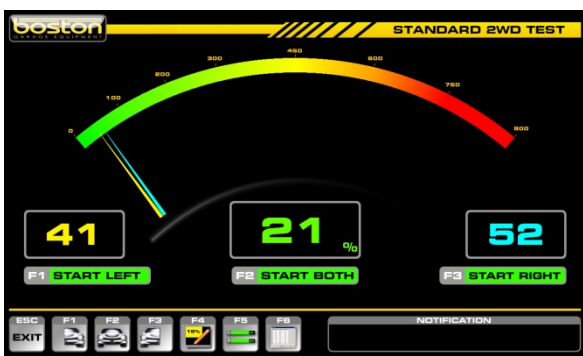

The rollers have stopped and the LEFT and RIGHT readings display the values used to calculate the imbalance result shown in the centre result box.

After the rollers have stopped, the results of maximum IMBALANCE achieved throughout the test are shown on the display. The readings shown are those which were used to calculate the imbalance percentage as shown in the centre result box. Refer to Chapter 5 for permissible limits.

8. Once all tests have been completed for the front axle, the user can save them to be used in the overall brake efficiency calculation. To do this, select F4 ASSIGN TEST DATA and select where to save the results. As this is a FRONT AXLE test, select F7 to ASSIGN FRONT AXLE.

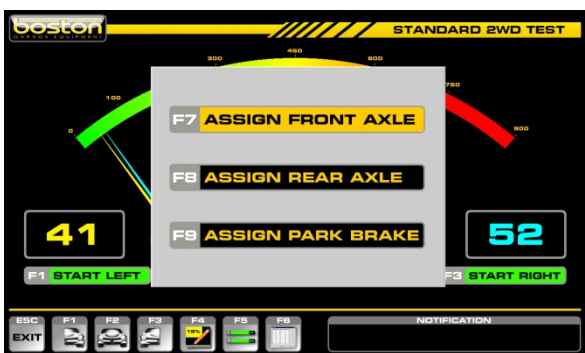

Select F7 to assign all the results from the FRONT AXLE test to memory.

## Testing Rear Axle

- To test the rear axle, drive the vehicle forward and place the rear wheels in the RBT. Repeat steps 1 to 8 above but when assigning the test results, select F8 ASSIGN REAR AXLE to store in the correct memory location. If the F7 ASSIGN FRONT AXLE is selected, the previous test results will be overwritten.

### NOTE

Once the vehicle axle leaves the RBT for more than 2 seconds, the RBT will re-weigh the axle before starting the rollers. The software recognises the need to weigh the rear axle as the time period between the front axle exiting the RBT and the rear axle entering the RBT will always exceed 2 seconds. However, this time period also allows the RBT to re-test the front axle should it become ejected from the rollers during a test. As the exit duration is usually less than 2 seconds the RBT will not re-weigh the axle.

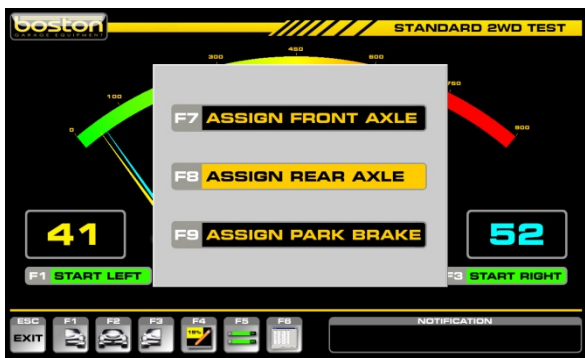

Select F8 to assign all the results from the REAR AXLE test to memory.

## Testing the Parking Brake

- The parking brake is tested in the same way as the service brake but instead the user operates the vehicle's parking brake (numbers 2 to 6). If the parking brake is located on the front axle then the user should perform the parking brake test before placing the rear axle in the rollers. The same applies if testing the rear axle first.



Select F9 to assign the results for the PARKING BRAKE to memory.

## Test Results and Printing

Once the full test has been completed and all results are saved in their respective locations, select F6 – TEST RESULTS. The following results page will be shown.

BRAKE TEST RESULTS				
TESTERS NAME:	BRAD		VEHICLE MODEL:	335D
VEHICLE TYPE:	2 WHEEL DRIVE		MILEAGE:	12000
VEHICLE REG:	E057 BNA		TOTAL WEIGHT:	808 kg
VEHICLE MAKE:	BMW		AXLE WEIGHT (kg):	F: 404 R: 404
<b>XXX = WHEEL LOCK</b>	LEFT [kgf]	RIGHT [kgf]	IMB [%]	EFF [%]
SERVICE BRAKE FRONT	225	238	23	57
SERVICE BRAKE REAR	225	238	20	57
TOTAL FORCE	450	476	---	114
PARKING BRAKE	226	238	---	57
NOTIFICATION <b>HIGH EFF, LOW WEIGHT</b>				

The results page contains two main sections, vehicle specific information (as entered by the user at the beginning of the test) and the results table.

The vehicle data is shown at the top of the page. If the RBT is fitted with a vehicle weighing system, the weight for both the front and rear axles is shown individually. If the user entered the total weight at the beginning of the test, the 'AXLE WEIGHT' line will not be shown.

The test results grid contains all the results as stored by the user during the test. Only if all results were stored correctly can the software calculate the correct brake efficiencies. In the example above, all data has been saved and we can see the efficiencies calculated on the right side of the table.

The results shown in red indicate that the wheel locked during the test, so this test shows that all wheels locked including the parking brake. If we compare the results of this test against the MOT limits, we can see that the vehicle has passed on SERVICE BRAKE efficiency as the total efficiency of 114% is much higher than the 50% required. Similarly, the PARKING BRAKE achieved a total brake efficiency of 57%, more than the minimum 25% required. Finally, as the BRAKE IMBALANCE is below 25% on the front axle, this vehicle meets the PASS criteria for an official test.\*

As this is a MANUAL UNOFFICIAL test, the software does not generate or display a PASS or FAIL result. However, from this page the user can choose to print the results as many times as required by selecting the F1-PRINT button. The printout contains all the same information that is shown on this page together with the testing station information. A sample printout can be seen on the following page.

\* - limits specified may change for vehicles of different ages and types

**Sample Printout from a STANDARD TEST**

The garage logo can be placed here if required. See the SW900 User Manual for further information.

BRAKE TEST RESULTS

---

**EQUIPMENT**

MAKE: BOSTON  
MODEL: D412+MC1  
SERIAL NO.: 1234567890

**TEST DATE / TIME**

DATE: Fri, 13 Nov 2009  
TIME: 11:26:51

---

**TESTING STATION**

VTS NO.: 4456  
STATION NAME: Gidea Park Motoring Ctr  
ADDRESS: 232 Main Road, Romford, Essex, England, RM2 5HA  
TELEPHONE: +44 (0)1234 567890  
TESTERS NAME: BRAD

---

**VEHICLE DETAILS**

VEHICLE MAKE: BMW  
VEHICLE MODEL: 335D  
VEHICLE REG.: E057 BNA  
VEHICLE MILEAGE: 12000

**VEHICLE TYPE: 2 WHEEL DRIVE**

TOTAL VEHICLE WEIGHT: 808 kg  
FRONT AXLE WEIGHT: 404 kg  
REAR AXLE WEIGHT: 404 kg

---

**TEST RESULTS**

[\*] = lock

	LEFT [kgf]	RIGHT [kgf]	IMBALANCE %	EFFICIENCY %
FRONT SERVICE BRAKE	225*	238*	(40) 23 (52)	57
REAR SERVICE BRAKE	225*	238*	(44) 20 (55)	57
TOTAL SERVICE BRAKE	450	476	---	114
PARKING BRAKE	226*	238*	---	57

TEST NOTES: HIGH EFFICIENCY, LOW WEIGHT

---

Boston Garage Equipment, 199 New Road, Rainham, Essex, RM13 8SJ, United Kingdom  
T: +44 (0)1708 525585 F: +44 (0)1708 525408 info@boston-ge.com www.boston-ge.com

This section contains information about the test equipment and when the test was carried out.

This section contains information about the testing station and the tester.

This section contains information about the vehicle as entered by the user at DATA-ENTRY.

This section contains the test results

This section shows notes automatically generated by the software about the test.

The buttons at the bottom of the display offer the user some other options. A list of the button functions is shown below.

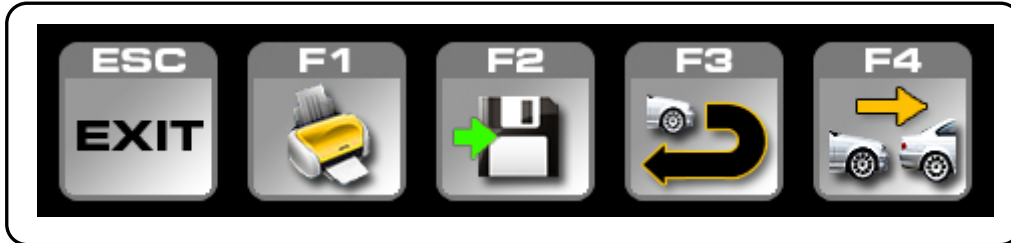

Button	Function
ESC	ESCAPE back to previous page
F1	Print results
F2	Save customer details and test results
F3	Repeat the test on the same vehicle (no data-entry required)
F4	Start a new test



## Testing 3 Wheeled Vehicles (3WV)

Three wheeled vehicles can only be tested in the MANUAL mode. They are tested in much the same way as standard four wheeled vehicles but because one axle has a single wheel, the user must choose which roller is used to test it.

The following procedure should be followed to test three wheeled vehicles.



Complete the DATA ENTRY page as before but select 3 WHEEL VEHICLE as the vehicle type. The TEST TYPE will be set to MANUAL and the class of test to CLASS III as default. The user can also set the class of test to CLASS IV should the weight of the unladen vehicle exceed 450kg. Select CONTINUE.

The PLACE VEHICLE IN ROLLERS page is now shown. When testing a standard 4 wheeled vehicle, both detect rollers must be depressed before the software will continue into the test program, when testing a 3 wheeled vehicle, either roller can be depressed and the software will continue.

Place either axle in the rollers, although usually the front axle contains the single wheel and is tested first. When the wheel is inserted, the wheel detect indicator turns green.



Only one DETECT roller needs to be depressed. The user can select either roller for testing.

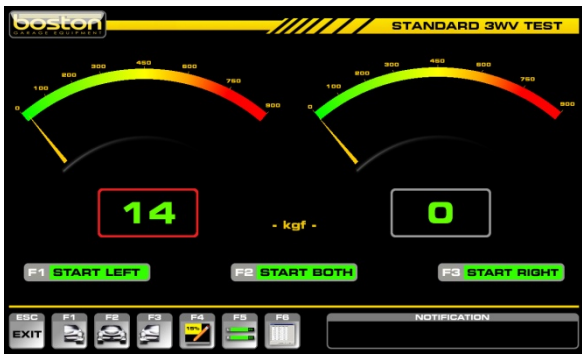

The page title at the top right will indicate 3WV test.

For testing the single wheel, the user can only use the roller that detected the wheel, the other roller will not operate without a wheel present.

After testing the single wheel, the user should save the test result to the relevant axle in the same way as for the standard test.

Drive the vehicle out of the rollers and place the second axle to be tested in the RBT. Now perform the individual LEFT and RIGHT SERVICE BRAKE tests as described in numbers 2 to 6 above and assign the results to relevant axle.

Perform the IMBALANCE test on the two-wheeled axle as described in number 7 above.

To view the results select F6 and print as necessary.

## Testing Four Wheel Drive Vehicles (4WD)

Four wheel drive vehicles can only be tested in the MANUAL mode. They are tested in much the same way as standard four wheeled vehicles but because the wheels of a single axle (or multiple axels) are sometimes permanently connected together, it is necessary to rotate the opposite wheel under test in the opposite direction to avoid damage to the transmission.

This means that during the testing of the FRONT LEFT wheel, the RBT will also start the FRONT RIGHT roller but in the opposite direction.

### NOTE

*Always refer to the manufacturer's specifications before testing 4WD vehicles. Some types of 4WD vehicles cannot be tested on the RBT and as such it is the user's responsibility for ascertaining the type of transmission being tested. Always ensure that the correct buttons on the remote control are used.*

### CAUTION

*During the testing of 4WD vehicles, the opposite brake roller will operate in the reverse direction.*

The following procedure should be followed to test 4WD vehicles.



**STANDARD - DATA ENTRY**

TESTERS NAME: **BRAD**

VEHICLE TYPE: **4 WHEEL DRIVE**

TEST TYPE: **MANUAL**    **CLASS IV**

VEHICLE REG.: **E057 BNC**    YEAR: **2007**

VEHICLE MAKE: **BMW**

VEHICLE MODEL: **X5**

MILEAGE: **12000**

ENGINE SIZE: **3000 cc**

**F2 CONTINUE**

ESC EXIT    F1    F2

NOTIFICATION  
**CONTINUE**

Complete the DATA ENTRY page as before but select 4 WHEEL DRIVE as the vehicle type. The TEST TYPE will be set to MANUAL. Select F2 CONTINUE.

The PLACE VEHICLE IN ROLLERS page is now shown. Insert the front axle of the vehicle into the RBT. Both detect rollers must be depressed before the software will continue into the test program.

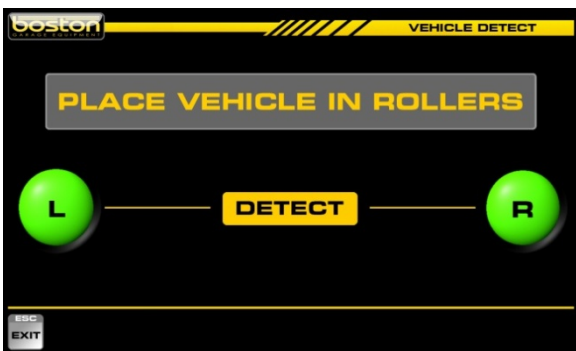

Both wheels have been placed in the rollers as shown by the two green indicators. This page is shown only for a few seconds before the software moves on to the vehicle testing page.



The page title at the top right will indicate 4WD test.

The text 4x4 is shown in the opposite display when testing 4WD vehicles. The active roller under test shows the live data.

During the testing of the FRONT LEFT wheel, the text 4x4 is shown in the right side results box. The right side roller is also operating but in the reverse direction.

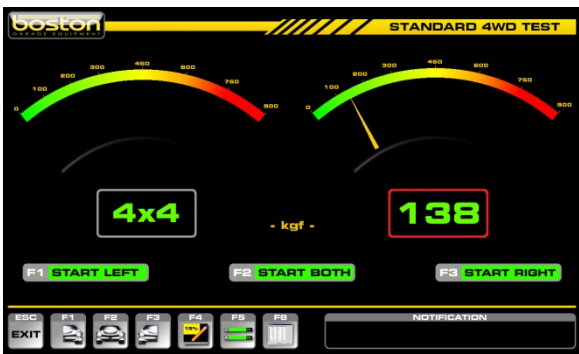

During the testing of the FRONT RIGHT wheel, the text 4x4 is shown in the left side results box. The left side roller is also operating but in the reverse direction. In this display layout, the analogue needle pointer is removed from the inactive measurement display.

After the LEFT and RIGHT wheels have been tested individually, the IMBALANCE test can be carried out in the normal way.

Once the IMBALANCE test is complete and all data has been saved, drive the vehicle forward and place the REAR wheels in the rollers.

Repeat the procedure for the SERVICE BRAKE REAR and the PARKING BRAKE, and save the data to the relevant axle using F4 on the keyboard or remote control.

## Testing Motorcycles

Unlike most Class 4 RBT's, the D412 is able and approved to test motorcycles (provided the motorcycle software has been installed). This is a very useful and cost effective solution as separate roller beds for motorcycles can be expensive. The testing procedure is similar to the standard vehicle test although only one roller is used.

### CAUTION

*Motorcycle testing can only be carried out when the MC1 cover plate adapter has been fitted. The plate limits the width of the open roller surface to accommodate the narrow wheels of motorcycles. It is dangerous and prohibited to test motorcycles without the MC1 cover plate fitted.*

For official testing, there are DVSA regulations where testing bays have specific dimensional requirements. It is important that these are adhered to if the user intends to carry out official motorcycle testing using the D412. This section covers STANDARD TESTS only; official testing is covered later on in the manual.

To perform a motorcycle test, ensure the MC1 cover plate is securely fitted (refer to Chapter 3 - MC1 Motorcycle Testing Cover Plate) and follow the procedures below.

### Testing Motorcycles with Single Brake Control Systems



Complete the DATA ENTRY page as before but select MOTORCYCLE as the vehicle type. The TEST TYPE will be set to MANUAL and the class of test to CLASS II. Select CONTINUE.

The PLACE VEHICLE IN ROLLERS page is now shown. When testing a standard 4 wheeled vehicle, both detect rollers must be depressed before the software will continue into the test program, when testing a motorcycle, either roller can be depressed and the software will continue.

Place either wheel in the rollers, although usually the front wheel is tested first. When the wheel is inserted, the wheel detect indicator turns green. Make sure that the motorcycle is positioned in a straight line and that it is not in gear. The rider should sit on the motorcycle as in a normal situation.

At this point, whichever roller has been depressed by the user to carry out the test is the roller that should be used for testing the whole motorcycle. The software will disable the opposite roller until a new DATA-ENTRY page is completed and the user chooses a roller for the first time.



Only one DETECT roller needs to be depressed. The user can select either roller for testing but once selected this roller must be used for the duration of the test.

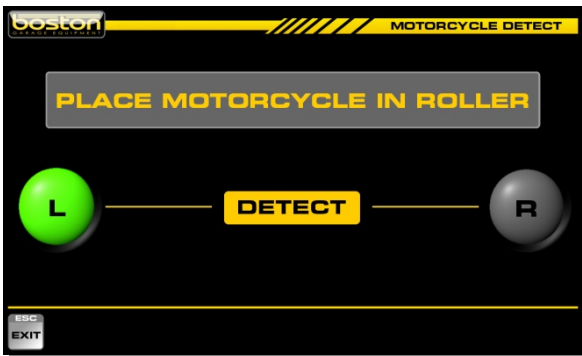

In this example we have used the LEFT roller for testing the motorcycle..



F5

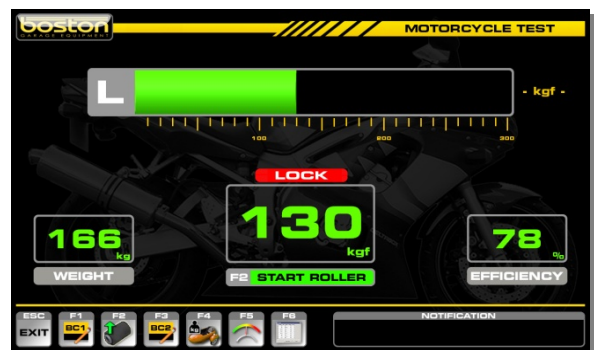

The motorcycle layout displays are a little different from the standard layouts. This is because there are no LEFT and RIGHT readings as motorcycles only have FRONT and REAR readings (and sidecar if fitted). This display shows a single scale to display the force from a single brake system, the weight obtained from the wheel being tested and the efficiency result at the end of the test.

The motorcycle procedure can also be carried out using the horizontal bar display layout (as above). The user can choose to 'toggle' between the two layouts by selecting F5.

At the bottom of the display there are a number of function buttons which are used to control and navigate the test procedure. The buttons are sometimes different for each page depending on the functions available for the specific page. For the STANDARD TEST motorcycle brake test screens, the buttons remain the same irrespective of the layout chosen by the user. A layout of the buttons and their respective functions is shown below.



Button	Function
ESC	ESCAPE back to previous page
F1	ASSIGN result to BRAKE CONTROL 1
F2	START ROLLER
F3	ASSIGN result to BRAKE CONTROL 1
F4	ASSIGN measured weight to SIDECAR
F5	Change display layout
F6	Show results page

To the right of the function buttons there is a NOTIFICATION BOX. Instructions and messages are shown in the box for the user to follow. The example below shows the text ROLLER STARTING to alert the user.



## Testing the Front Wheel

Once the front wheel is in the rollers the following page is shown.



From the testing page select F2 START ROLLER to start the roller. The software will automatically acquire the axle weight.

↓ F2 – START ROLLER



The user must remain steady on the motorcycle to ensure an accurate weight measurement.

↓



The measured weight is shown for approximately 3 seconds before the display returns back to the testing page.

As before, the user is alerted to the rollers starting by means of the audible buzzer and the flashing red indicators on the display. When the roller starts, carefully position the wheel in the centre of the roller before applying the brake. This is important with larger / heavier motorcycles as they can be difficult to handle.



With the roller running, slowly apply brake force to the first brake control (BC1) until the wheel locks or maximum force is achieved. If the roller cannot be locked then stop the roller by pressing any key on the remote control or keyboard. The highest brake force reading achieved will be displayed.



The efficiency will be calculated after the brake force measurement has been completed.



Once the brake force reading has been taken, the user must assign the result to memory. Select F1 or F3 depending on which brake control was used. For this example we will assume this test is the FRONT wheel using the HAND brake control BC1.

Select F1 (BC1) and assign the reading to the FRONT by selecting F7.



ASSIGN front wheel brake force measurement from brake control 1 to the FRONT.

### **Brake force fluctuations (Ovality)**

After the brake force measurement has been assigned, the operator can test the front wheel for brake force fluctuations. Follow the procedure below:

- Select F2 to re-start the roller (if the wheel has been removed from the roller for more than 2 seconds then weight measurement will be re-taken, but the weight value is not required for this test).
- With the roller running, slowly increase the brake force and hold it steady at a constant value of approximately half the maximum value measured in the first test. Visually check for brake force fluctuations on that wheel. Fluctuations are easier to see on the analogue graphical display.
- The user should note and interpret any irregularities in the brake force behaviour.
- Release the brake quickly and observe the way in which the braking effort reduces.
- Press any key to stop the rollers

**Testing the Rear Wheel**

Drive the motorcycle forward and place the REAR wheel in the RBT. Be careful to align the wheel in the centre of the roller.

Select F2 to start the roller. The software will take a new axle weight measurement and display the reading. After the weight measurement, the software will show exactly the same testing page as before.

As before, the user is alerted to the rollers starting by means of the audible buzzer and the flashing red indicators on the display. When the roller starts, carefully position the wheel in the centre of the roller before applying the brake.

The rear wheel is usually controlled by the FOOT brake (brake control 2). Slowly apply brake force until the wheel locks or maximum force is achieved. If the roller cannot be locked then stop the roller by pressing any key on the remote control or keyboard. The highest brake force reading achieved will be displayed.

Once the brake force reading has been taken, the user must assign the result to memory. Select F3 (BC2) and assign the reading to the REAR by selecting F11.



↓ F3 – Brake Control 2



ASSIGN rear wheel brake force measurement from brake control 2 to the REAR.

After the brake force measurement has been assigned for the rear wheel, the operator should again test the rear wheel for brake force fluctuations. Follow the same Brake Force Fluctuations procedure as was done for the front wheel.

### Testing Motorcycles with Linked (Dual) Brake Control Systems

If the first brake control system (BC1 – Hand Brake) also operates on the rear wheel, then the user should select F1 (BC1) and then F8 ASSIGN REAR to assign the result from the REAR wheel to brake control 1. The software now has two results (front and rear) for the first brake control system.

Similarly, if the second brake control system (BC2 – Foot Brake) also operates on the front wheel, then the user should select F3 (BC2) and then F10 ASSIGN FRONT to assign the result from the FRONT wheel to brake control 2. The software now has two results (front and rear) for the second brake control system.



Assign REAR wheel result to BC1 when FIRST brake control operates on the REAR wheel.



Assign FRONT wheel result to BC2 when SECOND brake control operates on the FRONT wheel.

#### **NOTE**

Every time the user stores a new result in BC1 or BC2, the software will overwrite the previously stored result.

## Testing Sidecars

If the motorcycle is fitted with a sidecar, both the weight and any brake force produced by one of the two brake control systems needs to be measured.

To enter the weight of the sidecar, follow the procedure below:

- After completing the brake tests for the front and rear wheels, select F4 SIDE-CAR WEIGHT and place the sidecar on the roller bed.



↓ F4 – Side-Car Weight



Place sidecar on the bed and wait for the weight reading to become stable. Press ENTER to assign the weight.

Note: If the RBT is not fitted with an automatic weighing system, the operator should enter the weight value manually and press ENTER.



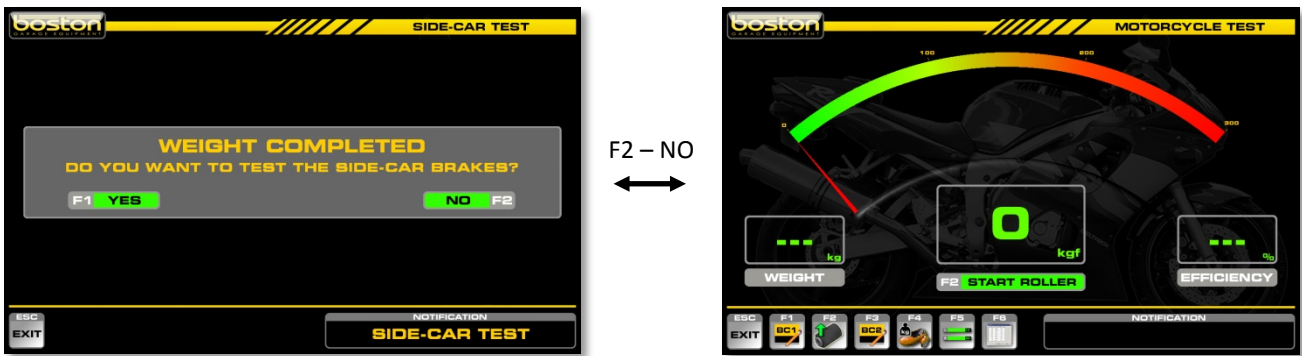

After the sidecar weight has been acquired, the operator can choose to test the sidecar brake (if fitted and controlled by either BC1 or BC2).

To test the brake on the sidecar, follow the procedure below:

- Select F1 – YES from the WEIGHT COMPLETED screen (shown above).
- Place the wheel of the sidecar in the roller. Ensure the wheel is positioned centrally in a straight line and that the motorcycle is not in gear.
- Press ENTER to start the test.



- Slowly operate the brake on the sidecar (by using BC1 / BC2) until the wheel locks or maximum force is achieved. If the roller cannot be locked then stop the roller by pressing any key on the remote control or keyboard. The highest brake force reading achieved will be displayed.
- Select F1 or F3 to assign the sidecar force measurement to either BC1 or BC2.
- After the measurements have been assigned select F6 to view the results. Provided all results have been correctly saved, the software will determine the overall efficiency for each brake control system.

If the sidecar is not controlled by either of the two brake controls or is operated by an independent control, only the weight of the sidecar is relevant in the overall calculations of the brake test. The weight must be taken and entered into the system.

---

**NOTE**

*During the weight measurement of the sidecar, it is important that no other part of the motorcycle is on the roller bed, this will provide an inaccurate weight reading and the test results may not be valid.*

---

**Test Results**

The screenshot below shows the results from a standard motorcycle test. The layout is exactly the same as for the other types of vehicle tests and with the same button functions available at the bottom of the display.

**MOTORCYCLE RESULTS**

TESTERS NAME: **BRAD**      VEHICLE MODEL: **2X7R**  
 VEHICLE TYPE: **MOTORCYCLE**      MILEAGE: **1200**  
 VEHICLE REG: **E057 BND**      TOTAL WEIGHT: **312 kg**  
 VEHICLE MAKE: **KAWABAKI**

XXX = WHEEL LOCK	FRONT [kgf]	REAR [kgf]	SIDECAR [kgf]	EFF [%]
BRAKE CONTROL 1	129	...	...	41
BRAKE CONTROL 2	...	129	...	41
TOTAL	129	129	...	83
WEIGHT [kg]	156	156	...	

ESC EXIT    F1    F2    F3    F4      NOTIFICATION

The screenshot below shows the same results page as above but with the added weight of the sidecar. With the added weight, we can see how the efficiencies have changed.

**MOTORCYCLE RESULTS**

TESTERS NAME: **BRAD**      VEHICLE MODEL: **2X7R**  
 VEHICLE TYPE: **MOTORCYCLE**      MILEAGE: **1200**  
 VEHICLE REG: **E057 BND**      TOTAL WEIGHT: **487 kg**  
 VEHICLE MAKE: **KAWABAKI**

XXX = WHEEL LOCK	FRONT [kgf]	REAR [kgf]	SIDECAR [kgf]	EFF [%]
BRAKE CONTROL 1	129	...	...	27
BRAKE CONTROL 2	...	129	...	27
TOTAL	129	129	...	53
WEIGHT [kg]	156	156	175	

ESC EXIT    F1    F2    F3    F4      NOTIFICATION



**Motorcycle Sample Printout**

**BRAKE TEST RESULTS**

---

**EQUIPMENT**

**TEST DATE / TIME**

MAKE: BOSTON

MODEL: D412+MC1

SERIAL NO.: 1234567890

DATE: Fri, 13 Nov 2009

TIME: 17:10:26

---

**TESTING STATION**

VTS NO.: 4456

STATION NAME: Gidea Park Motoring Ctre

ADDRESS: 232 Main Road, Romford, Essex, England, RM2 5HA

TELEPHONE: +44 (0) 1234 56789

TESTERS NAME: BRAD

---

**VEHICLE DETAILS**

VEHICLE MAKE: KAWASAKI

VEHICLE MODEL: ZX7R

VEHICLE REG.: EO57 BND

VEHICLE MILEAGE: 1200

VEHICLE TYPE: MOTORCYCLE

TOTAL VEHICLE WEIGHT: 487 kg

---

**TEST RESULTS**

[\*] = lock

	FRONT [kgf]	REAR [kgf]	SIDECAR [kgf]	EFFICIENCY %
BRAKE CONTROL 1	129*	---	---	27
BRAKE CONTROL 2	---	129*	---	27
TOTAL	129	129	---	53

WEIGHT [kg]	156 kg	156 kg	175 kg	---
-------------	--------	--------	--------	-----

TEST NOTES:

---

Boston Garage Equipment, 199 New Road, Rainham, Essex, RM13 8SJ, United Kingdom  
T: +44 (0) 1708 525585 F: +44 (0) 1708 525408 info@boston-ge.com www.boston-ge.com

## Automated Brake Test

**NOTE:** The latest DVSA procedure can be found inside ANNEX A – Document title BOS0483

The automated brake test is only available for standard 2 wheel drive vehicles. If the user selects any other type of vehicle from the DATA ENTRY page, the software will only allow for a manual test.

The automated program carries out the test in a different way to the standard test. For each part of the automated test, both rollers are started together and the brake force measurement is taken at the same time for both wheels on the axle. After each test, the software automatically saves the results and there is no need for any user control.

The automatic test only requires that the user complete the DATA ENTRY page at the beginning of the test and the rest of the procedure is completely automated up until the BIND, GRAB and JUDDER page.

The automated test is carried out in the following order.

1. First Axle Service Brake - LEFT and RIGHT
2. First Axle Service Brake - Imbalance between both rear wheels
3. Parking Brake (if front axle) - LEFT and RIGHT
4. Parking Brake (if rear axle) - LEFT and RIGHT
5. Second Axle Service Brake - LEFT and RIGHT
6. Second Axle Service Brake - Imbalance between both rear wheels

In some cases, the PARKING BRAKE may act on the front wheels and it may be necessary to test the PARKING BRAKE with the front wheels still in the rollers. If the parking brake is connected to the FRONT axle then this must be selected by the user on the pop-up window shown after completing the DATA ENTRY page.

The AUTOMATED software procedure is shown below:



Complete the DATA ENTRY page as before but select TEST TYPE: AUTOMATED. Select CONTINUE.

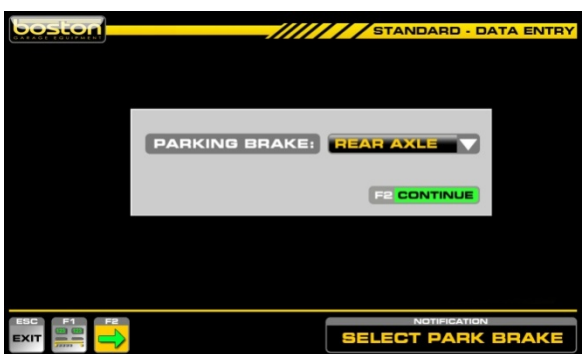

The next page asks the user to confirm the location of the PARKING BRAKE. This is usually fitted to the REAR axle and the software defaults to REAR. However, if it is fitted to the FRONT axle then select it here. The AUTOMATED procedure is different for each option.

After completing the DATA ENTRY page select F2 to continue. From this point onwards the procedure is automatic and the user must follow the on-screen instructions. See below.

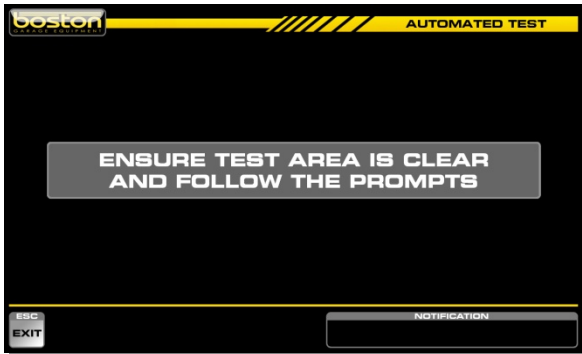

The software is waiting for the user to insert the front wheels in the rollers. The green detect indicators will light when the corresponding wheel is detected.

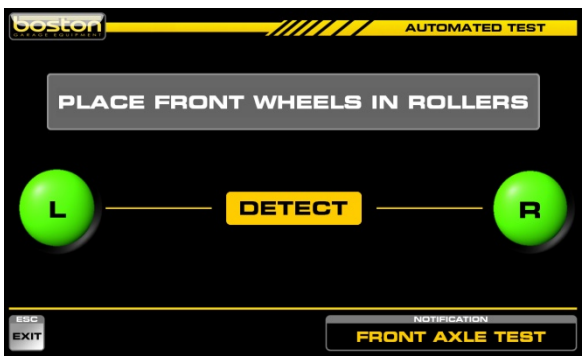

The wheels have been detected and this page is shown for approximately 2 seconds,



The axle is weighed automatically. This page is shown for approximately 4 seconds. The axle weight is then shown.



The rollers will start automatically and the operator is prompted to centralise the wheels in the rollers. This message is shown for 2 seconds.

For safety reasons, whenever the rollers are running, the large outer boxes of the digital readings are shown in red.

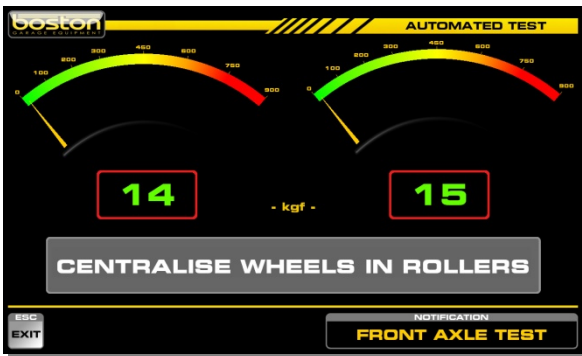

The message CENTRALISE WHEELS IN ROLLERS is shown for 2 seconds, the operator is then prompted to slowly apply the service brake to maximum.

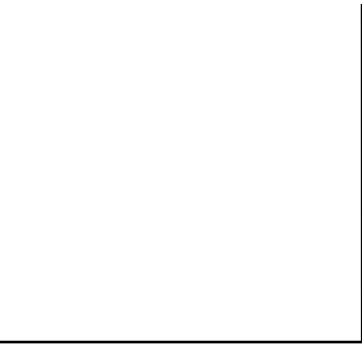
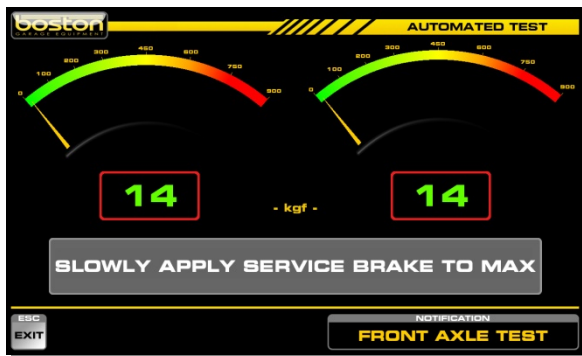

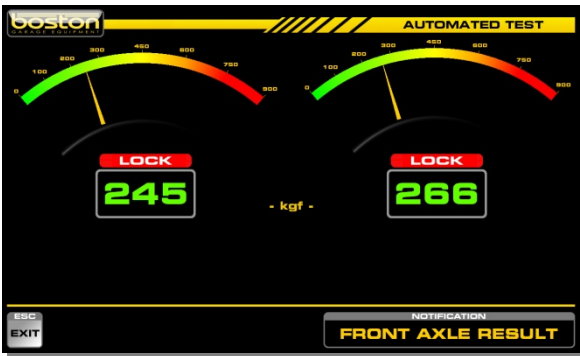

If wheel lock is achieved, the LEFT and RIGHT indicators will show. If wheel lock cannot be achieved, the software will automatically stop the rollers when stable readings have been measured for 3 seconds.

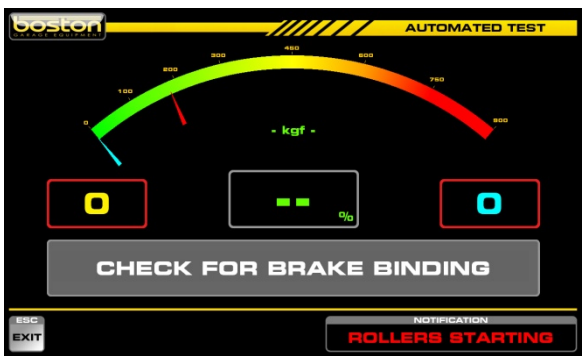

After the SERVICE BRAKE test, the software will re-start the rollers. The user is asked to CHECK FOR BRAKE BINDING. This message is shown for two seconds. There is no software measurement for brake binding and the user must make a note if present.

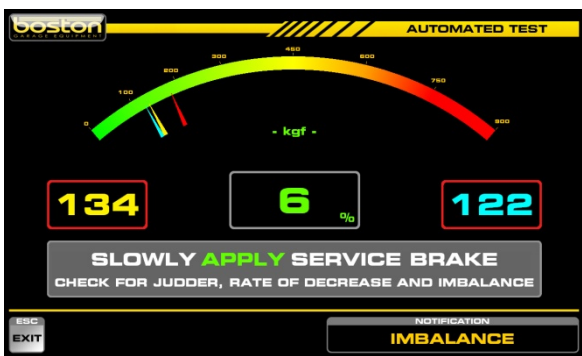

The software now checks for IMBALANCE. The user must SLOWLY APPLY THE SERVICE BRAKE until the force from either wheel reaches 75% of the maximum force achieved in the previous SERVICE BRAKE test. The red needle indicates this value and when reached, an audible bleep is sounded by the software. If wheel lock is achieved during this test the software automatically restarts the rollers.

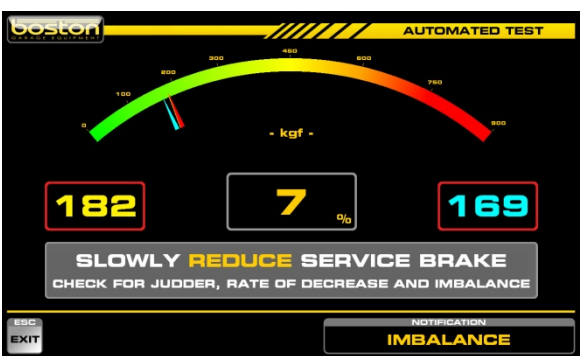

Once the force has reached 75% of the previous maximum, the message SLOWLY REDUCE SERVICE BRAKE is shown. The user must reduce brake effort and the software will automatically turn off the rollers when the brake force falls below 40kgf.

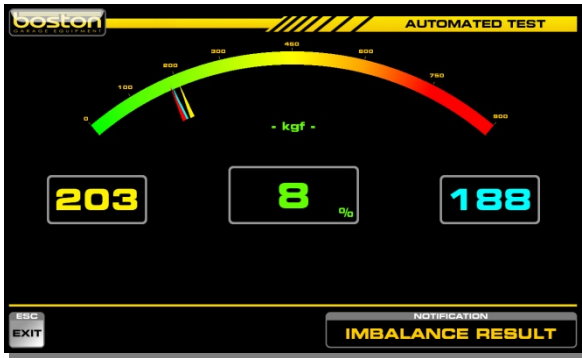

After the rollers have stopped, the IMBALANCE result is shown for a few seconds before the software moves on to test the rear wheels.

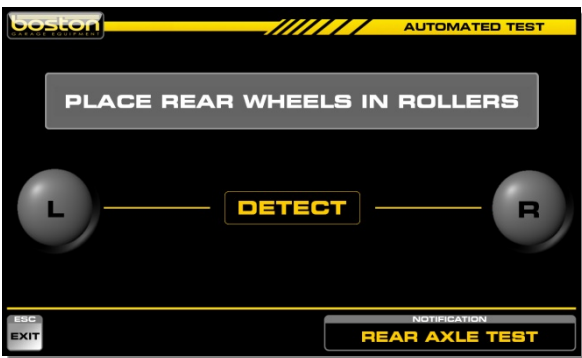

The user must now place the REAR wheels in the rollers.  
**If PARKING BRAKE: FRONT was selected on the DATA ENTRY page, the software will carry out the parking brake test BEFORE moving to the rear wheels test.**

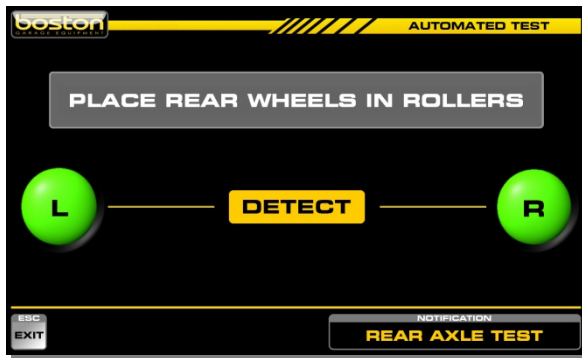

The wheels have been detected and this page is shown for approximately 2 seconds.



The axle is weighed automatically. This page is shown for approximately 4 seconds. The axle weight is then shown.



The rollers will start automatically and the operator is prompted to CENTRALISE WHEELS IN ROLLERS. This message is shown for 2 seconds.

For safety reasons, whenever the rollers are running, the large outer boxes of the digital readings are shown in red.

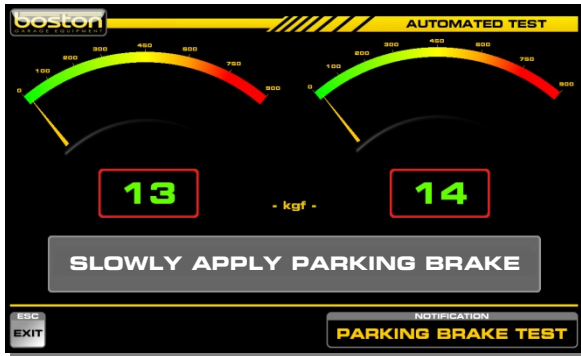

After centralising the wheels, the operator is prompted to SLOWLY APPLY PARKING BRAKE.

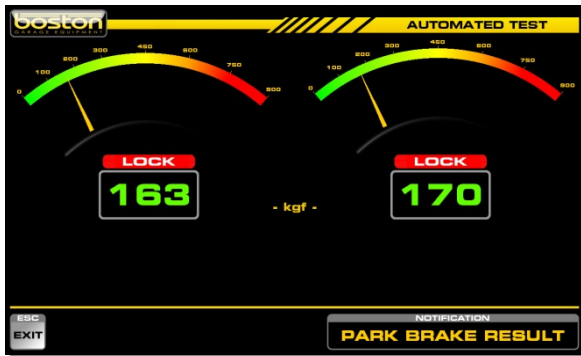

If wheel lock is achieved, the LEFT and RIGHT indicators will show. If wheel lock cannot be achieved, the software will automatically stop the rollers when stable readings have been measured for 3 seconds

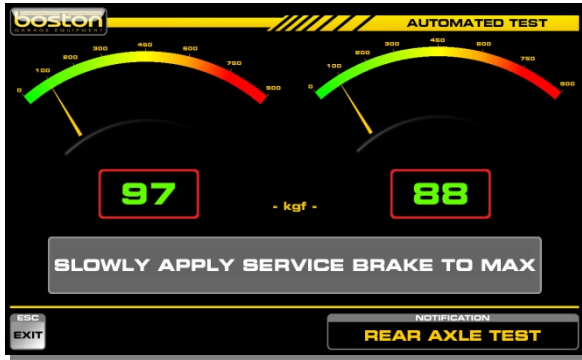

Once the PARKING BRAKE test is complete the software must check the SERVICE BRAKE. The software automatically restarts the rollers and instructs the user to SLOWLY APPLY SERVICE BRAKE TO MAX.

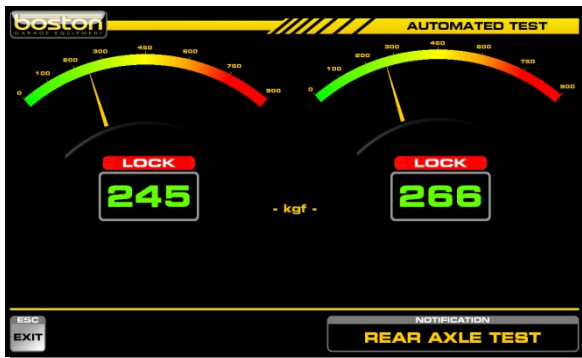

If wheel lock is achieved, the LEFT and RIGHT indicators will show. If wheel lock cannot be achieved, the software will automatically stop the rollers when stable readings have been measured for 3 seconds.

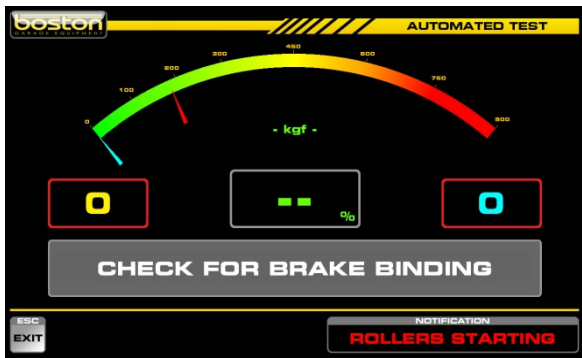

After the SERVICE BRAKE test, the software will re-start the rollers. The user is asked to CHECK FOR BRAKE BINDING. This message is shown for two seconds. There is no software measurement for brake binding and the user must make a note if present.

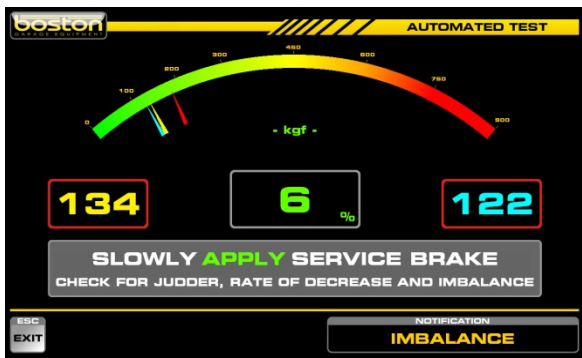

The software now checks for IMBALANCE. The user must SLOWLY APPLY THE SERVICE BRAKE until the force from either wheel reaches 75% of the maximum force achieved in the previous SERVICE BRAKE test. The red needle indicates this value and when reached, an audible bleep is sounded by the software. If wheel lock is achieved during this test the software automatically restarts the rollers.



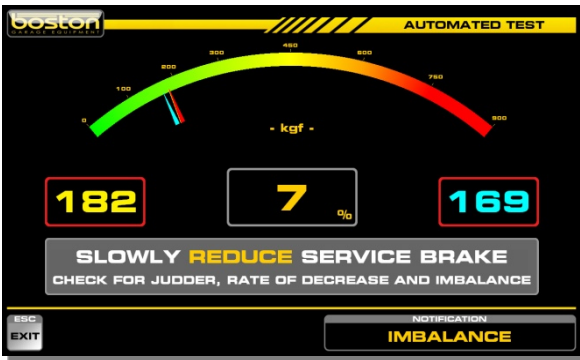

Once the force has reached 75% of the previous maximum, the message **SLOWLY REDUCE SERVICE BRAKE** is shown. The user must reduce brake effort and the software will automatically turn off the rollers when the brake force falls below 40kgf.

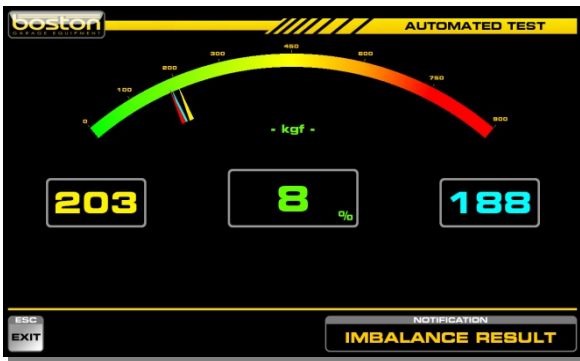

After the rollers have stopped, the **IMBALANCE** result is shown for a few seconds before the software completes the test.

**NOTE:** The result from the **REAR AXLE IMBALANCE** test has no bearing on the overall test result and is for information purposes only.

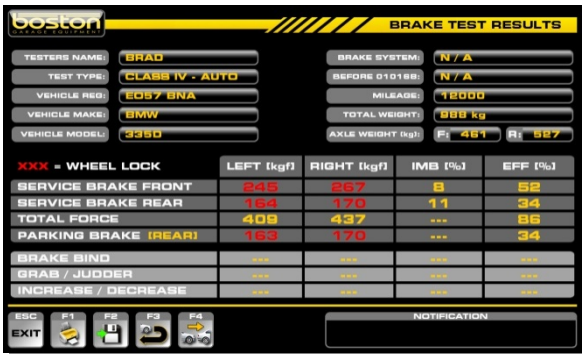
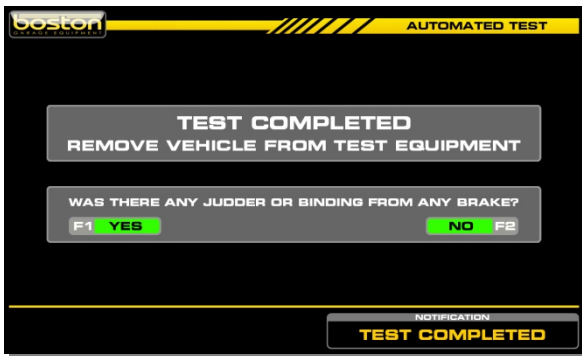

The test is now complete and the user is asked if there was any **BIND**, **GRAB** or **JUDDER** from any wheel during the test. If so, the user must select **F1** and complete the page above. If not, then select **F2 NO** and the results page will be shown.

Once the AUTOMATED test is complete, the user can choose to print the results, save the test, repeat the test or begin a new test. If the user wishes to save the test, a pop-up window is shown where the user can enter the contact details of the customer if required. By completing this information, the user can later search the software database by using either the vehicle details or customer details such as post code etc.

A screenshot of the pop-up for customer details is shown below:

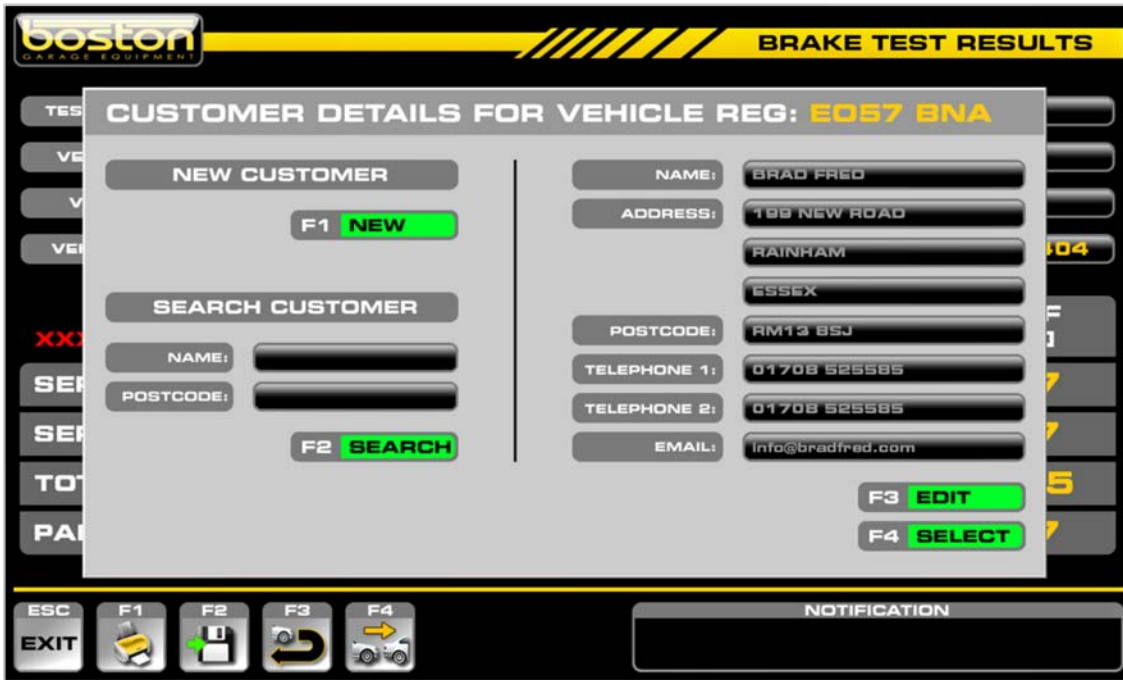

## Saving Test Results

From the BRAKE TEST RESULTS page, as shown at the end of any STANDARD test, the user can choose to save the test results for future use. To do this, select F2-SAVE DATA and a pop-up customer details window will be shown.

The software will automatically search the internal database for the vehicle registration number and any associated customer details, if there is a match then the customer's details will automatically be shown.

If the customer's details are still correct the user can select F4-SELECT to save the new test results against the existing vehicle and customer.



Select F4-SELECT to save the new test results against the existing customer and vehicle.

If the vehicle no longer belongs to the customer shown, the user can select F1-NEW and enter the new customer details.



Select F1-NEW to enter new customer details.

If the customer is known to the user and has a previously stored record on the system, the user can enter the customer’s name into the SEARCH NAME box and select F2-SEARCH. Once the customer has been found the user can select F4-SELECT to assign the test details and vehicle registration to the customer.



Enter the customers name or postcode to search the database.

If more than one record is found with matching search criteria, the user can use the arrow keys to scroll through the available records.

If the customer’s name is correct but the user needs to change the address details, the option F3-EDIT can be used. This option allows the user to change the contact information ONLY. The software will show a warning page prior to enabling the edit function to ensure the user is aware of the permanent change to the customer’s record.

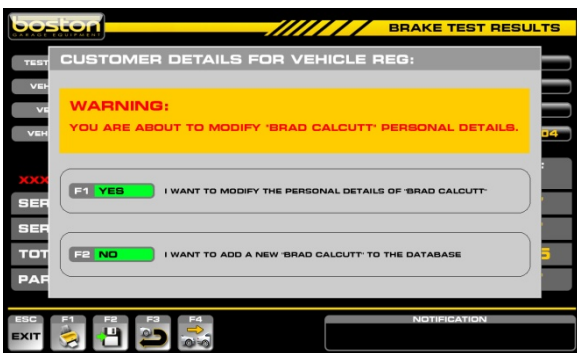

Refer to the SW900 software manual for information on how to recall and use the customer / vehicle test database.

### In This Chapter

---

Official Tests - Data Entry	70
Manual Test - 2WD Vehicles	74
Testing 3 Wheeled Vehicles (3WV)	79
Testing Four Wheel Drive Vehicles (4WD)	79
Testing Motorcycles	79
Official Automated Brake Test	80

This chapter describes how to carry out an OFFICIAL brake test using both the MANUAL and AUTOMATED software procedures. The OFFICIAL TEST option should be used for official testing, and for all quick standard tests the STANDARD TEST option should be used. This manual assumes that installation of the RBT is complete and the software is fully enabled for the user. This manual also assumes that the user is familiar with the SW900 software and has read the SW900 software manual.

Before continuing, it is important to note and check the following:

- Always refer to the DVSA MOT Inspection Manual when carrying out an official test.
- Brake forces are indicated in kgf.
- Weight input is indicated in kg.
- Imbalance is indicated in %.
- Brake efficiency is indicated in %.
- Examine the tyres to ensure they are not under-inflated, if the tyre pattern is in good condition and if the tyres are free from mud and stones.
- Determine whether the vehicle has a single brake control system or a split (dual) brake control system.
- Ensure the roller covers are removed from the RBT.
- Ensure the wheels of the vehicle are always placed centrally in the rollers before starting the test.
- Understand the quick stop emergency procedures should they be required.

---

#### **NOTE**

*All references on the software pages to the 'F' keys on the keyboard also relate to the same function keys on the RF remote control. The following procedures do not relate to the remote control although the functions of the keyboard and remote control are the same.*

---

OFFICIAL brake tests are performed in exactly the same way as STANDARD brake tests, the only difference being that that some specific information is compulsory on the DATA ENTRY page before the software will allow the user to continue.

### Official Tests - Data Entry

From the MAIN MENU, select option F2 'OFFICIAL TESTS' and follow the procedure below to reach the DATA ENTRY page.



F1 – OFFICIAL TESTS

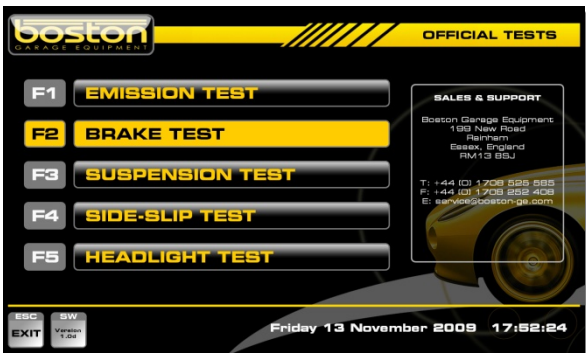

F2 – BRAKE TEST

From this page the user selects the type of test required. If the relevant hardware and software is installed the software will continue into the respective program, if not, the message 'ACTIVATION REQUIRED' is shown. Similarly, if no tester's names have been set, the message 'SET TESTERS NAMES' will be shown.



The OFFICIAL DATA ENTRY page allows the user to enter specific vehicle data for the vehicle about to be tested. As the software is able to test different types of vehicles, it is important to ensure that the data is correct before selecting continue. The available types of test for MANUAL and AUTOMATED are shown below.

MANUAL TEST OPTIONS	AUTOMATED TEST OPTIONS
Motorcycle Test	2 Wheel Drive Vehicle Test
2 Wheel Drive Vehicle Test	
3 Wheeled Vehicle Test	
4 Wheel Drive Test	

Using the mouse and keyboard, enter the relevant information into the DATA ENTRY page. It is not compulsory for the user to enter all vehicle specific data for the MANUAL tests, but the **VEHICLE TYPE** and **TEST TYPE** entry fields must be completed to allow the software to follow the correct route.

If the user wishes to carry out an AUTOMATED test, then some specific fields must be completed on the DATA ENTRY page before the software will continue. There is also a second DATA ENTRY page to complete when carrying out an AUTOMATED test. If data is missing from the required entry fields the message DATA MISSING is shown.

### Official Test - Required Vehicle Information

#### MANUAL TESTS

- There is no compulsory information required when selecting MANUAL test although we suggest completing as many fields as possible to ensure printouts and saved tests contain as much relevant data as possible.

#### AUTOMATED TESTS – CLASS IV

- Vehicle Make                   COMPULSORY
- Vehicle Model                COMPULSORY
- Vehicle Registration        COMPULSORY
- Brake System Type           COMPULSORY
- Park Brake Position         COMPULSORY

#### AUTOMATED TESTS – CLASS VII

- The same as CLASS IV **plus** the DGW (Design Gross Weight).

#### AUTOMATED TESTS – CLASS VL

- The same as CLASS VII **plus** Vehicle First Used

### **Test Selection Criteria**

- If the user selects MOTORCYCLE from the VEHICLE TYPE pull-down menu, the TEST TYPE will automatically be set to MANUAL, CLASS 2.
- If the user selects 4 WHEEL DRIVE as the vehicle type, the TEST TYPE is automatically set to MANUAL. The option for AUTOMATED is not available.
- If the user selects 3 WHEELED VEHICLE as the vehicle type, the TEST TYPE is automatically set to MANUAL, CLASS 3 (CLASS 4 can still be selected by the user). The option for AUTOMATED is not available.
- If the RBT is fitted with a vehicle weighing system the WEIGHT box is not shown.
- The YEAR field is completed automatically by the software depending on the registration of the vehicle. Eg. If the registration of the vehicle is EO57 then the year is set to 2007. Although this field is set initially, it can also be edited by the user in the event that the year cannot be ascertained from the registration number (vehicles with very old or personalised number plates).
- The FIRST USED field is completed automatically by the software depending on the year. This field is used primarily for the vehicle emissions testing procedures and is not relevant to the RBT test, however, if completed; it will be shown on the printout.
- The pull-down menus on this page can be operated using the PC mouse, the TAB / ARROW keys on the keyboard or the remote control.

---

### **NOTE**

*The default settings when first entering into this page are: **2 WHEEL DRIVE, AUTOMATED and CLASS IV.** The display layout can also be set by selecting F1.*

---



### Test Selection Criteria – DATA ENTRY page 2

The second DATA ENTRY page is only shown for the AUTOMATED test. See screenshot below.

- The default setting for the BRAKE SYSTEM field is DUAL LINE.
- The default setting for the PARKING BRAKE field is REAR AXLE.
- The default setting for the TRANSMISSION field is empty data.
- The default setting for the FUEL TYPE field is empty data.
- The default setting for the TURBO field is empty data.
- The default setting for the ENGINE SIZE field empty data.

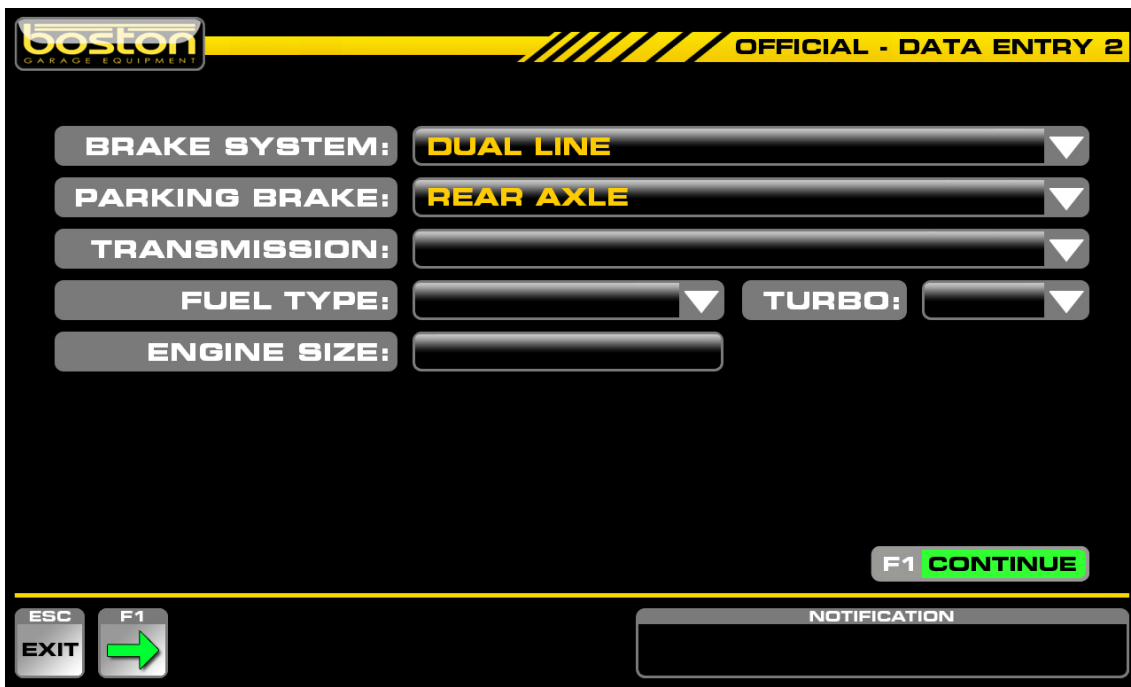
The screenshot shows a software interface for data entry. At the top left is the "boston GARAGE EQUIPMENT" logo. To the right, a yellow banner reads "OFFICIAL - DATA ENTRY 2". Below this, there are five rows of input fields. The first row is "BRAKE SYSTEM:" with a dropdown menu showing "DUAL LINE". The second row is "PARKING BRAKE:" with a dropdown menu showing "REAR AXLE". The third row is "TRANSMISSION:" with an empty dropdown menu. The fourth row has two dropdown menus: "FUEL TYPE:" and "TURBO:". The fifth row is "ENGINE SIZE:" with an empty text input field. At the bottom right, there is a green button labeled "F1 CONTINUE". At the bottom left, there are two buttons: "ESC EXIT" and "F1" with a green arrow pointing right. At the bottom center, there is a grey box labeled "NOTIFICATION".

The compulsory fields are already completed by the software as default and the user can select F1-CONTINUE if the data is correct for the vehicle being tested.

## Manual Test - 2WD Vehicles

The OFFICIAL MANUAL testing procedure for standard 2WD Class 4 vehicles is exactly the same as the test procedure described above in Chapter 5. The only difference between the STANDARD and OFFICIAL test procedures is the need to note and manually tell the software if there was any BIND, GRAB or JUDDER from any of the wheels during the test.

To explain this clearly we shall continue on from a test page shown earlier in the STANDARD TEST procedure.

We shall assume that.-

- The FRONT LEFT wheel has been tested.
- The FRONT RIGHT wheel has been tested.
- The FRONT IMBALANCE has been tested.
- The REAR LEFT wheel has been tested.
- The REAR RIGHT wheel has been tested.
- The REAR IMBALANCE has been tested.
- The PARKING BRAKE LEFT has been tested.
- The PARKING BRAKE RIGHT has been tested.

The page below shows the result of the test on the PARKING BRAKE RIGHT. At this point the user already has all the results from all wheels and is ready to select F6 RESULTS.

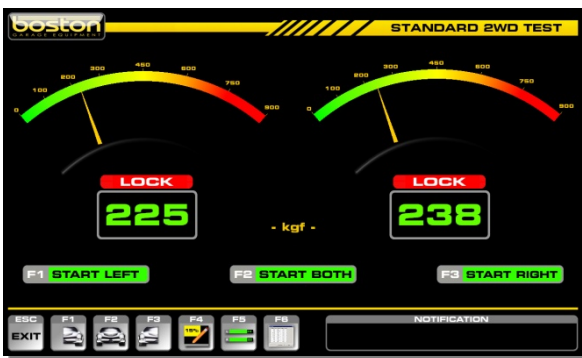

As we are now testing using the OFFICIAL TESTS procedure, when the user selects F6 RESULTS, a different page is shown that allows the user to enter BIND, GRAB or JUDDER for each wheel.

This information is not detected or measured by the software; it must be looked for and noted by the tester as the test is being carried out. The user must select (by using the mouse, remote control or TAB/ARROW keys) which wheel (if any) exhibited any signs of BIND, GRAB or JUDDER. To do this, click in the open oval or by pressing the TAB key on the remote, a yellow bar is shown underneath the selection. The bar can be navigated around the table using the arrow keys. See screenshot below:

This screen shot shows the default page without any selections made.

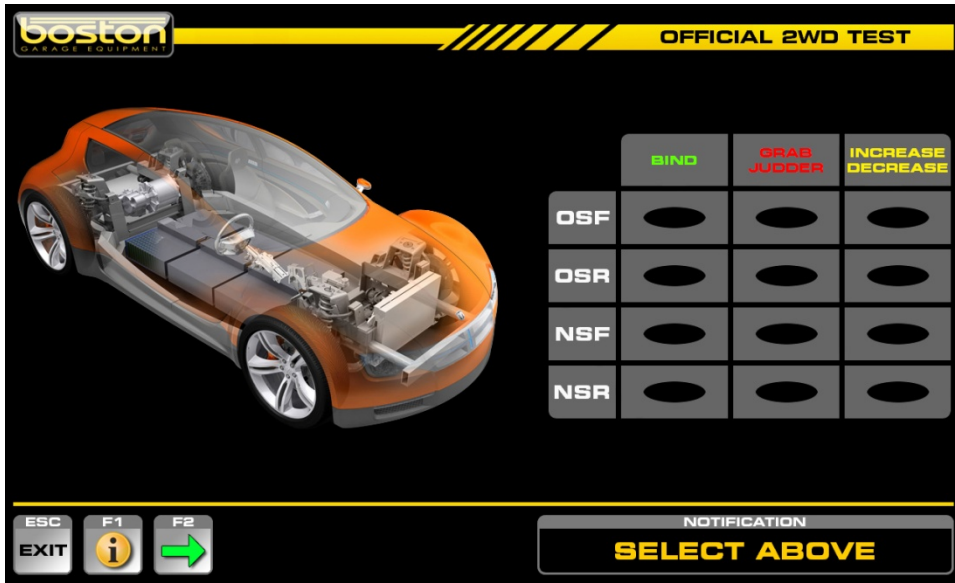

- OSF = Off Side Front (Driver side)
- OSR = Off Side Rear (Driver side)
- NSF = Near Side Front (Passenger side)
- NSR = Near Side Rear (Passenger side)

When a selection is made, a coloured tag is shown against the corresponding wheel. See below.



Select the TAB key from either the remote control or the keyboard, a yellow line will appear in the table which can be moved between selections by using the arrow keys.

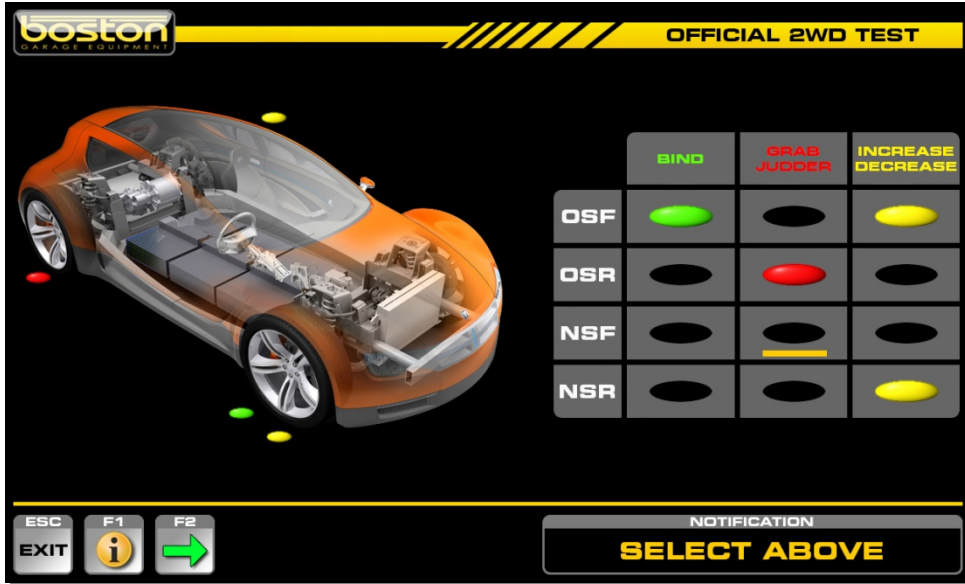

To assist the user, the option F1 INFORMATION is available to describe the operation of the page. See below.

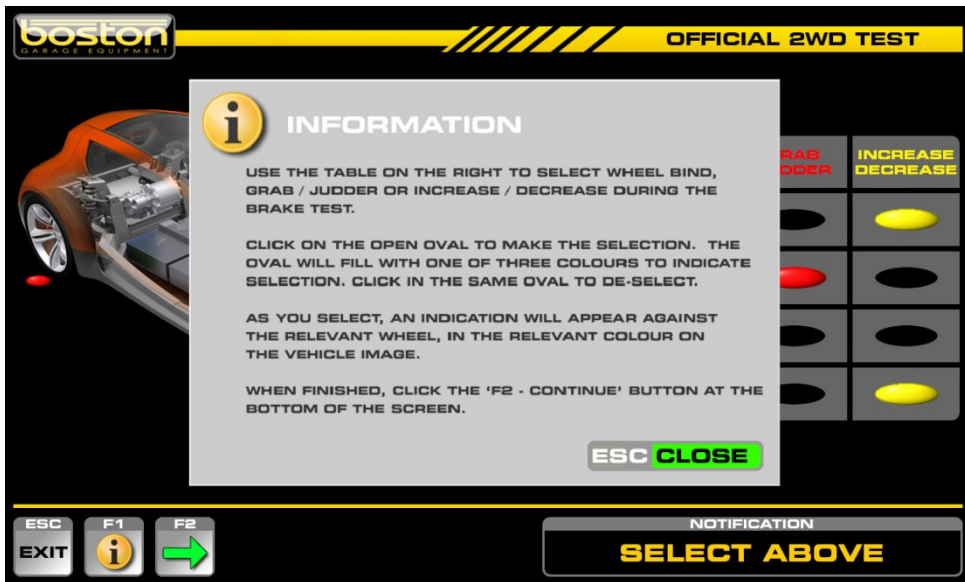

Once all selections have been made, select F2 CONTINUE to proceed to the results page.

The OFFICIAL TEST results page is slightly different to that from the STANDARD TEST. The top section of the page shows the vehicle and test specific information that was completed during data-entry, and the table of results has extra rows to show the information entered by the user on the BIND, GRAB and JUDDER page.

BRAKE TEST RESULTS

TESTERS NAME: **BRAD**

TEST TYPE: **CLASS IV - MAN**

VEHICLE REG: **222**

VEHICLE MAKE: **222**

VEHICLE MODEL: **222**

BRAKE SYSTEM:

BEFORE 010168:

MILEAGE: **222**

TOTAL WEIGHT: **1004 kg**

AXLE WEIGHT (kg): F: **502** R: **502**

XXX = WHEEL LOCK	LEFT [kgf]	RIGHT [kgf]	IMB [%]	EFF [%]
SERVICE BRAKE FRONT	226	238	21	46
SERVICE BRAKE REAR	225	238	20	46
TOTAL FORCE	451	476	---	92
PARKING BRAKE	225	237	---	46
BRAKE BIND	---	---	---	---
GRAB / JUDDER	---	---	---	---
INCREASE / DECREASE	---	---	---	---

ESC  
EXIT

F1

F2

F3

F4

NOTIFICATION

If the user correctly saved the data for each wheel during the test, the software will automatically calculate the brake efficiencies for the front and rear axles. For AUTOMATED tests, the software stores the results automatically during the test and produces a PASS / FAIL result.

For information about the PASS or FAIL limits see Chapter 7.

**NOTE**

*If BIND, GRAB or JUDDER is selected for any wheel, the test result will always be FAIL, irrespective of the brake efficiencies achieved by each wheel.*



**Sample Printout from an OFFICIAL TEST**

The garage logo can be placed here if required. See the SW900 User Manual for further information.

BRAKE TEST RESULTS

---

EQUIPMENT

MAKE: BOSTON  
MODEL: D412+MC1  
SERIAL NO.: 1234567890

TEST DATE / TIME

DATE: Sat, 14 Nov 2009  
TIME: 22:32:25

---

TESTING STATION

VTS NO.: 4456  
STATION NAME: Gidea Park Motoring Ctr  
ADDRESS: 232 Main Road, Romford, Essex, England, RM2 5HA  
TELEPHONE: +44 (0) 1234 567890  
TESTERS NAME: BRAD

---

VEHICLE DETAILS

TEST TYPE: CLASS IV  
VEHICLE MAKE: BMW  
VEHICLE MODEL: 335D  
VEHICLE REG.: EO57 BNA  
VEHICLE MILEAGE: 12000  
TRANSMISSION:

CLASS OF TEST: MANUAL  
BRAKING SYSTEM:  
BEFORE 01.01.68:  
TOTAL VEHICLE WEIGHT: 1018 kg  
FRONT AXLE WEIGHT: 509 kg  
REAR AXLE WEIGHT: 509 kg

---

TEST RESULTS

[*] = lock	LEFT [kgf]	RIGHT [kgf]	IMBALANCE %	EFFICIENCY %
FRONT SERVICE BRAKE	225*	238*	(42) 20 (53)	45
REAR SERVICE BRAKE	226*	238*	(44) 20 (55)	46
TOTAL SERVICE BRAKE	451	476	---	91
PARKING BRAKE	226*	237*	---	46
BRAKE BIND	---	---	---	---
BRAKE GRAB / JUDDER	---	---	---	---
BRAKE INC. / DECR.	---	---	---	---

TEST RESULT: PASS

- CUSTOMER COPY -

---

Boston Garage Equipment, 199 New Road, Rainham, Essex, RM13 8SJ, United Kingdom  
T: +44 (0)1708 525585 F: +44 (0)1708 525408 info@boston-ge.com www.boston-ge.com

This section contains information about the test equipment and when the test was carried out.

This section contains information about the testing station and the tester.

This section contains information about the vehicle as entered by the user at DATA-ENTRY.

This section contains the test results

This section shows notes automatically generated by the software about the test.

The two small sets of numbers in brackets are the values that were used by the software to calculate the imbalance. See chapter 7 for limits and calculations.

DOC: BOS0481

78 / 93

ENGLISH

## Testing 3 Wheeled Vehicles (3WV)

The OFFICIAL MANUAL testing procedure for standard 3WV vehicles is exactly the same as the test procedure described above in Chapter 5. The only difference between the STANDARD and OFFICIAL test procedures is the need to note and manually tell the software if there was any BIND, GRAB or JUDDER from any of the wheels during the test.

The procedure to follow for completing the BIND, GRAB or JUDDER page is explained earlier in this chapter under **Manual Test – 2WD Vehicles**.

When printing the test results from the results page, the software will produce two copies. One copy is for the testing station and the printout shows the text GARAGE COPY at the bottom, the other is for the customer and shows the text CUSTOMER COPY.

## Testing Four Wheel Drive Vehicles (4WD)

The OFFICIAL MANUAL testing procedure for standard 4WD vehicles is exactly the same as the test procedure described above in Chapter 5. The only difference between the STANDARD and OFFICIAL test procedures is the need to note and manually tell the software if there was any BIND, GRAB or JUDDER from any of the wheels during the test.

The procedure to follow for completing the BIND, GRAB or JUDDER page is explained earlier on in this chapter under **Manual Test – 2WD Vehicles**.

When printing the test results from the results page, the software will produce two copies. One copy is for the testing station and the printout shows the text GARAGE COPY at the bottom, the other is for the customer and shows the text CUSTOMER COPY.

## Testing - Motorcycles

The OFFICIAL MANUAL testing procedure for testing motorcycles is exactly the same as the motorcycle test procedure described above in Chapter 5, but with the addition of the BIND, GRAB or JUDDER page for the user to complete.

When printing the test results from the results page, the software will produce two copies. One copy is for the testing station and the printout shows the text GARAGE COPY at the bottom, the other is for the customer and shows the text CUSTOMER COPY.

## Official Automated Brake Test (ATL)

The OFFICIAL AUTOMATED brake test is only available for standard 2 wheel drive vehicles. If the user selects any other type of vehicle from the DATA ENTRY page, the software will only allow for a MANUAL test.

The automated program carries out the test in a different manor to the standard test. For each test, both rollers are started together and the brake force measurement is taken at the same time for both wheels on the axle. After each test, the software automatically saves the results and there is no need for any user control.

Unlike the STANDARD automated test, the OFFICIAL AUTOMATED procedure requires that further information is completed on both DATA ENTRY pages (see DATA ENTRY at the beginning of this chapter).

The automated test is carried out in the following order.

1. First Axle Service Brake - LEFT and RIGHT
2. First Axle Service Brake - Imbalance between both rear wheels
3. Parking Brake (if front axle) - LEFT and RIGHT
4. Parking Brake (if rear axle) - LEFT and RIGHT
5. Second Axle Service Brake - LEFT and RIGHT
6. Second Axle Service Brake - Imbalance between both rear wheels

In some cases, the PARKING BRAKE may act on the front wheels and it may be necessary to test the PARKING BRAKE with the front wheels still in the rollers. If the parking brake is connected to the FRONT axle then this must be selected by the user on the second DATA ENTRY page.

The AUTOMATED software procedure is shown below:



Complete the DATA ENTRY page as before but select TEST TYPE: AUTOMATED. Select CONTINUE.

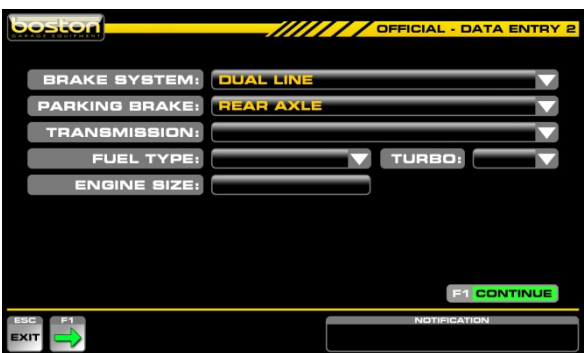

The second DATA ENTRY page must be completed correctly. This information is necessary for calculating the results and for the software to follow the correct testing procedure.



After completing the DATA ENTRY page select F2 to continue. From this point onwards the procedure is exactly the same as the automated procedure described in Chapter 6 up until the results page.

When the user reaches the results page, the software will automatically generate a PASS or FAIL result and produce TWO printouts, one for the testing station and the other for the customer. The software will also save the vehicle details and test data automatically in the internal database. The user has the option to also add the customer's details to the test information by selecting F2 SAVE DATA.

If the vehicle registration number and customer details have been stored on the system from a previous test, they will be shown automatically on the right side of the pop-up window; the operator only needs to select F4-SELECT to save the vehicle test results against the customer shown.

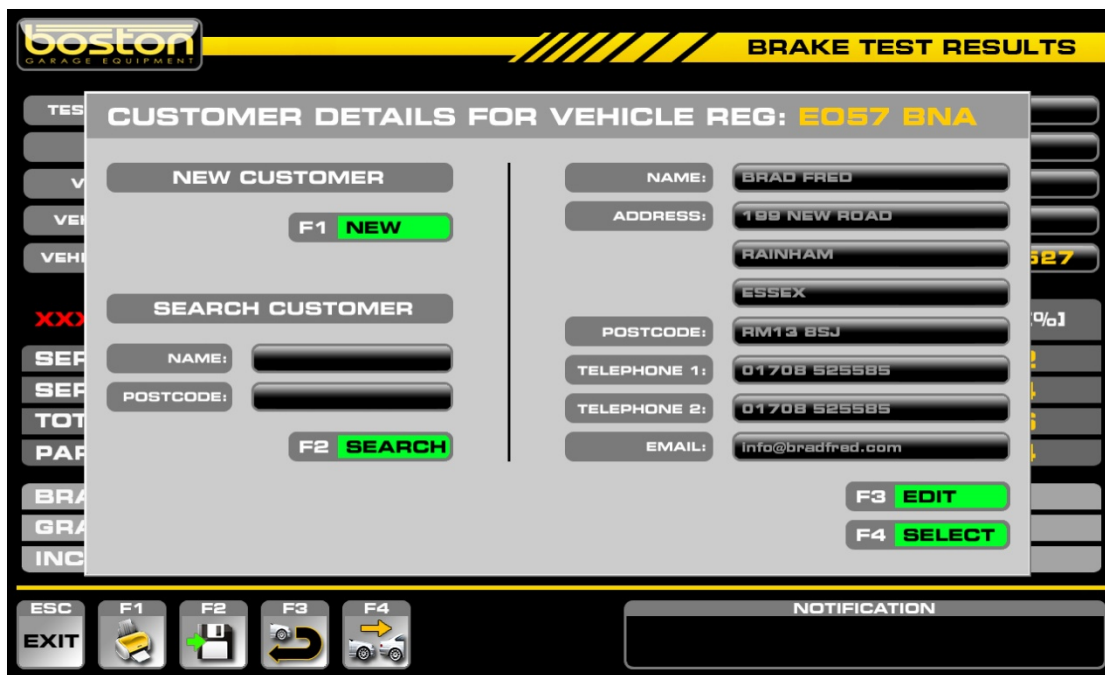

The screenshot displays the 'BRAKE TEST RESULTS' screen with a pop-up window titled 'CUSTOMER DETAILS FOR VEHICLE REG: E057 BNA'. The pop-up window is divided into two sections: 'NEW CUSTOMER' and 'SEARCH CUSTOMER'. The 'NEW CUSTOMER' section has a green 'F1 NEW' button. The 'SEARCH CUSTOMER' section has input fields for 'NAME:' and 'POSTCODE:', a green 'F2 SEARCH' button, and a 'F3 EDIT' button. The right side of the pop-up window contains a form with the following details:

NAME:	BRAD FRED
ADDRESS:	199 NEW ROAD
	RAINHAM
	ESSEX
POSTCODE:	RM13 8SJ
TELEPHONE 1:	01708 525585
TELEPHONE 2:	01708 525585
EMAIL:	info@bradfred.com

At the bottom of the pop-up window, there is a green 'F4 SELECT' button. The background screen shows a sidebar with various menu options and a bottom navigation bar with function keys: ESC EXIT, F1 (printer icon), F2 (save icon), F3 (refresh icon), and F4 (truck icon). A 'NOTIFICATION' box is visible at the bottom right of the main screen.

UK regulations require that the testing station keep a copy of the printout for a minimum of 3 months.

For further information about recalling customer / test information and using the internal software database please refer the SW900 software user manual available separately.

### In This Chapter

Brake Efficiency	82
Brake Imbalance	82
Efficiency Limits	83
Motorcycle Limits	84

### Brake Efficiency

The brake efficiency of each system is calculated from the total brake force of that system and expressed as a percentage of the vehicle weight.

To calculate the brake efficiency of a vehicle, follow the procedure below:

- Add together the braking effort from all wheels of the vehicle when the **service brake** is applied.
- Add together the braking effort recorded from the appropriate wheels when the **parking brake** is applied.
- Obtain the total weight of the vehicle. This can be determined from a Brake Data Chart or the automatic weighing system if fitted to the RBT.

**Efficiency calculation** (separate for service brake and parking brake):

$$\text{Efficiency \%} = \frac{\text{Total brake effort all wheels}}{\text{Total vehicle weight}} \times 100$$

The DVSA allows the use of an electronic calculator to perform the calculation of brake efficiency if necessary but provided the separate brake measurements are assigned correctly during the test, the SW900 software is able to show the efficiency for both the service brake as well as the parking brake.

### Brake Imbalance

The imbalance of brake force between the left and right wheels of an axle is expressed as a percentage of the higher brake force. The imbalance of the braking effort on an axle is obtained by comparing the brake efforts at each wheel when they are tested simultaneously.

**Imbalance calculation:**

$$\text{Imbalance \%} = \frac{\text{Higher brake effort} - \text{Lower brake effort}}{\text{Higher brake effort}} \times 100$$

The maximum permissible brake imbalance as specified in the MOT inspection manual is 25%.

## Efficiency Limits

CLASS OF VEHICLE	MINIMUM BRAKE EFFICIENCIES REQUIRED		
	SERVICE BRAKE	PARKING BRAKE	
		Vehicle with a single line braking system	Vehicle with a split (dual) braking system
Vehicles with 4 or more wheels having a service brake (foot-brake) operating on at least 4 wheels and a parking (handbrake) operating on at least 2 wheels.	50%	25%	16%
Vehicles with 3 wheels with a service brake operating on ALL wheels and a parking brake operating on at least one wheel which were first used:			
i) before 1 January 1968	40%	25%	16%
ii) on or after 1 January 1968	50%	25%	16%
Vehicles first used before 1 January 1968 which do NOT have one means of control operating on at least 4 wheels (or 3 for three wheeled vehicle) 30% from first 25% from second means of control and which have one brake system with two means of control or two brake means of control systems with separate means of control.	30% from first means of control	25% from second means of control	
Vehicles first used before 1 <sup>st</sup> January 1915	One efficient system required		

### NOTE

16% Parking Brake efficiency equates to a vehicle holding on a gradient of 6.25  
Information correct as of November 2009.

## Motorcycle Limits

The efficiency of each system operated by a single brake control is the ratio of the retarding force generated by that system divided by the weight of the machine and the rider. Most motorcycles have two controls, one operating the front wheel brake and the other operating the rear wheel brake. Where a linked or dual system is operated by one control, the retarding force used in the efficiency calculation is the total from both wheels when operated by that control only. In this case the other control will probably operate on one wheel.

### Efficiency calculation:

$$\text{Efficiency \%} = \frac{\text{Total retarding force for one system}}{\text{Total weight of motorcycle + rider}} \times 100$$

The MOT brake efficiency requirements are specified as:

- Minimum brake efficiency of not less than 30% when one of the brake controls is operated.
- Minimum brake efficiency of not less than 25% when the other brake control is operated.
- Minimum brake efficiency of not less than 30% when only one means of operating the brakes is required for motorcycles registered before 1 January 1927.

Source: the "MOT inspection manual Motor Cycle Testing, 2006 edition"

The DVSA allows the use of an electronic calculator to perform the calculation of brake efficiency if necessary, but provided the separate brake measurements are assigned correctly during the test, the SW900 software is able to calculate the brake efficiencies for each system.

- The first brake control system is called BC1 (usually the hand brake control system).
- The second brake control system is called BC2 (usually the foot brake control system).

If the motorcycle is fitted with a sidecar, the calculation of the brake efficiency can be as follows:

$$\text{Efficiency \%} = \frac{\text{Total kgf FRONT, REAR, SIDECAR for BC1}}{\text{Total weight of motorcycle + sidecar + rider}} \times 100$$

$$\text{Efficiency \%} = \frac{\text{Total kgf FRONT, REAR, SIDECAR for BC2}}{\text{Total weight of motorcycle + sidecar + rider}} \times 100$$

**In This Chapter**

Troubleshooting and Maintenance 85

**Troubleshooting and Maintenance**

If the RBT does not function as it should, the operator should only take action when the failure appears to be simple to solve; for example, changing the battery in the remote control. However, the SW900 software also contains a TROUBLESHOOTING section where helpful information about the products installed can be found. From here, the user may find relevant information in order to resolve or understand the reasons behind any problems. To enter this section, select F4-HELP & TRAINING from the main menu and then F2-TROUBLESHOOTING. Follow the on screen instructions.



The RBT is designed and constructed so that maintenance is kept to a minimum. Only authorised service technicians should carry out adjustments. They are trained and have suitable calibration instruments at their disposal.

Although the RBT requires very little maintenance, it is important that the following instructions are carried out properly:

- Check the roller coating twice a year (visually by the operator).
- Check the tension of the chains every four months.
- Lubricate the chain every 3 months when used intensively.

For periodic maintenance, calibration and service contact the Boston service department or your local distributor.

**CAUTION**

*Do not use high pressure or steam cleaners on the RBT. The brake tester should be kept clean and dust-free. Clean the sheet metal with a lukewarm soap solution. Do not use any aggressive or abrasive detergents. Do not spray the units with water.*

## In This Chapter

---

Warranty / Guarantee

87

## Warranty / Guarantee

We guarantee our products to be free from defects due to faulty material or bad workmanship for a period of 24 calendar months. The period of the guarantee commences from the date of delivery to the Purchaser or a delivery address requested by the Purchaser. Our liability is limited to the repair or replacement at our option, of parts found defective within the prescribed period arising solely from faulty material or bad workmanship, in products properly used solely for the purpose for which they were intended, and not due to wear and tear, misuse, neglect, improper adjustment or water ingress under any circumstances, and maintained in line with the maintenance instructions and/or service recommendations, and/or calibration requirements. Hoses, probes, magnetic sensors, cables, bulbs, batteries, remote controls and all consumables are entirely excluded from this guarantee.

Any product alleged to be defective should be reported immediately. If liability is accepted the product will be repaired or replaced. We are in no circumstances liable for any consequential or other loss or damage arising through any defect in our product, in lieu of any express or implied statutory or other warranties, guarantees, conditions or liabilities (whether as to fitness, quality, standard or workmanship or otherwise) which are excluded, the following provisions shall apply:

- The Purchaser shall not be entitled to rescind the contract or claim damages on any grounds whatsoever as to the suitability of the goods for any particular purpose, and the Purchaser assumes responsibility for the capacity and performance of the goods being sufficient and suitable for his purpose. The Purchaser agrees and confirms that no statement or representation has been made by Boston relating to the goods to be supplied under the contract, or, if any has been made, has not relied on it.
- Boston's liability in respect of any defect whether of quality, suitability or performance or otherwise in any goods supplied or for any loss, injury or consequential damage attributable thereto is limited to the terms of this guarantee and the Purchaser hereby acknowledges this to be a condition of purchase.
- This guarantee does not apply should equipment be operated or stored under adverse conditions unless specified in the relevant equipment leaflet/manual. The above guarantee is given in lieu of all other terms, conditions, warranties, guarantees, undertakings and representations, express

### In This Chapter

---

D412B Roller Bed Specification	88
RF-90 Remote Control Specification	89
BPC-091 Boston Mini PC Specification	90
MCU-090 Control Unit Specification	91

### D412B Roller Bed Specification

- Voltage: 3 phase 400 V / 50 Hz / 11.5 A
- Motor: 2 x 3 kW
- Testing speed: 2.9 km/h
- Max. Brake force (per wheel): 800 kgf
- Max. Axle load: 3,500 kg
- Weight roller bed: 425 kg
- Chassis dimensions: 2340 mm x 660 mm x 300 mm (L x W x H) without weight system
- Diameter of the rollers: 206 mm
- Roller width: 700 mm
- Roller centres dimension: 420 mm
- Friction roller surface: 0.8 $\mu$  dry / 0.6 $\mu$  wet

---

#### **NOTE**

*Specification subject to change without prior notification.*

---



## RFC-95 Remote Control Specification

- Impact resistant protective rubber casing
- Magnet: Neodymium
- PC Interface: USB
- Power supply: 2 x AAA Batteries
- Operational Range: 50m (approx.)
- Operational Platform: Windows 2000 / XP / Vista / 7
- Height: 23 mm
- Max Width: 47 mm
- Length: 157 mm
- Weight (inc. batteries): 160 g
- Dimensions (ABS body): 90 x 6 x 21 mm (L x W x D)
- Dimensions (rubber case): 100 x 75 x 27 mm (L x W x D)
- Communication: Radio Frequency (2.4GHz)
- Chassis: ABS Plastic

---

### **NOTE**

*Specifications subject to change without prior notification.*

---

**BPC-091 Mini PC Specification**

➤ Product Code:	BPC-091
➤ CPU:	Intel Atom 230 - 1.6GHz
➤ Memory:	2G DDR2
➤ HD Storage:	SATA 120GB+
➤ Ethernet:	10M / 100M
➤ Wifi:	802.11g
➤ Sound:	On-board
➤ Operating System:	Windows 7
➤ Power Supply:	12V DC / 5A
➤ Chassis:	Black Anodised Aluminium
➤ Keyboard:	Mini USB / PS2
➤ Mouse:	Optical - Mini USB / PS2
➤ RFC-95 RF Control:	Optional - Not included
➤ Weight:	1.8kg
➤ Dimensions (Base):	220 x 180 x 30 mm

---

**NOTE**

*Specifications subject to change without prior notification.*

---

## MCU-090 Control Unit Specification

- Product Code: MCU-090
- Power Supply: 3 phase 400 V / 50 Hz / 32 A
- Chassis: Painted Steel
- Weight: 4.5kg
- Dimensions : 500 x 510 x 90 mm
- Connectivity: USB

---

**NOTE**

*Specifications subject to change without prior notification.*

---

## Declaration of CE Conformity

Manufacturer: Boston Garage Equipment

Address: 199 New Road  
Rainham  
Essex  
RM13 8SJ  
United Kingdom

Equipment: Modules for testing passenger cars, vans, trucks and trailers, brake and/or suspension and/or sideslip or wheel play detection

Equipment modules: D412, D712 Roller Brake Testers

Year of manufacture: 2015

Boston Garage Equipment declares under its own responsibility that the above identified products conform to the international standards described in Directive 73/23, the Machinery Directive (Directive 89/392, according to the latest modification, which includes Directive 91/368, 93/44, 93/68 and 98/37) and to the EMC Directive (Directive 89/336, according to the latest modification, which includes Directive 91/263, 92/31, 93/68 and 98/13).

It is pointed out that it is not allowed to take modules into operation as part of a compounded installation before the latter has been declared to comply with the Machinery Directive. Any alteration to the equipment, improper use or installation voids this Declaration.

Boston equipment is supplied with the CE-mark:



Brad Calcutt : May 2015  
Boston Garage Equipment



Boston Garage Equipment - 199 New Road - Rainham - Essex - RM13 8SJ - United Kingdom

Tel: +44 (0)1708 525585 Fax: +44 (0)1708 525408  
Email: [info@boston-ge.com](mailto:info@boston-ge.com) Web: [www.boston-ge.com](http://www.boston-ge.com)