

**Operating Manual for
Roller Brake Tester
BPS-Kompakt- 3.0 to 6.0**

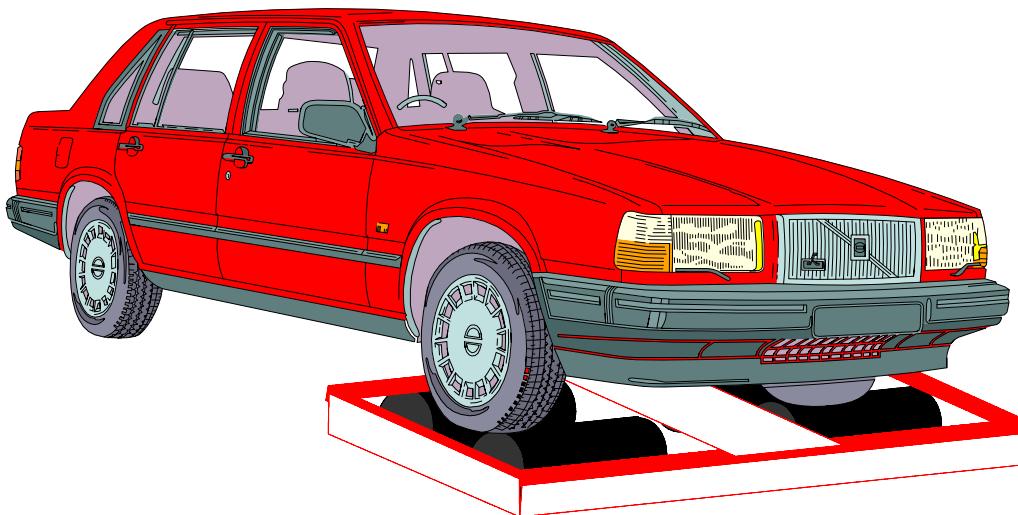

Despite careful content verification we cannot guarantee that this edition is free of errors.

This manual is intended for users with previous technical knowledge in the field of vehicle testing technology.

version	BA-BPS-K-3.0-6.0-D-120225
language:	English
Date:	25.02.2012

© Sherpa Autodiagnostik GmbH

Am Industriepark 11

D-84453 Mühldorf

Telephone: +49 (0) 8631 3766 -0

Telefax: +49 (0) 8631 161650

Internet: <http://www.sherpa.de>

E-Mail: info@sherpa.de

All rights reserved.

Technical modifications and all content contained herein are subject to change.

.Contents

1.	Important Basic Information.....	7
1.1	Scope of Delivery.....	7
1.2	Additional Equipment.....	7
1.3	Responsibilities of the Manufacturer in accordance with.....	7
1.4	Responsibilities of the Operator	7
1.5	External Interfaces	7
1.6	Legal Information	8
1.7	Documentation	8
1.8	Conventions.....	8
2.	Safety	10
2.1	Safety guidelines	10
2.2	Behaviour in the case of an emergency.....	10
2.3	Purpose and Use	10
2.4	Requirements for the Personnel	10
2.5	Health and Safety at Work.....	10
2.6	Safety-relevant environmental conditions.....	11
2.7	Assembly and Disassembly.....	11
2.8	Disposal	11
2.9	Compliance with the Operating Manual.....	11
2.10	Safety markings on the machine.....	11
2.11	Remaining risks and safety precautions	11
3.	Technical Information	12
3.1	Identification	12
4.	Description of the system.....	123
4.1	Range of Application.....	13
4.2	Main Component	14

4.3	Modes of Operation	16
5.	Installation Requirements	17
5.1	Installation.....	17
5.2	Functional Description	17
5.3	Description of the Process	17
5.4	Display Units	17
5.5	Assembly Site	18
5.6	Delivery and Installation Requirements of the Test Stand	18
5.7	Installation Plan	18
5.8	Entire Space Requirement	18
5.9	Dimensions and Weights	18
6.	Assembly and Installation, Initial Commissioning.....	19
6.1	Assembly Requirements	19
6.2	Safety.....	19
6.3	Assembly and Installation.....	19
6.4	Calibration device in accordance with ISO 17025.....	19
6.5	Initial Commissioning	19
6.6	Option lifting and lowering device	20
6.7	Option Remote Control	20
7.	Operation	212
7.1	Safety.....	22
7.2	Operating Elements.....	22
7.3	Display Units	23
7.4	Operation of the Test Stand.....	24
7.5	Modes of Operation	234
7.6	Remote Control.....	25
7.7	Motorcycle brake test (option).....	25

7.8	„Automatic all-wheel drive detection“ (option)	25
7.9	Electronic Control Box - General View	26
7.10	Test procedure automatic all-wheel drive detection.....	267
8.	Brief Operating Instructions.....	28
8.1	Start up the test stand.....	28
8.2	Entering the test stand.....	28
8.3	Brake Test	28
8.4	Leaving the test stand.....	28
8.5	Closing-down.....	28
9.	Trouble Shooting.....	29
9.1	Safety.....	29
9.2	Service Address.....	29
9.3	Location and marking of fuses.....	29
9.4	Error type detection.....	29
9.5	Error checklist	29
10.	Maintenance and Repair	32
10.1	Safety.....	32
10.2	Proof of Maintenance	32
10.3	Control Process and Testing Devices.....	32
10.4	Inspection and Maintenance Plan	32
10.5	Specification of the Inspection and Maintenance Plan.....	32
11.	Disassembly and Disposal	33
11.1	Safety.....	33
11.2	Disassembly.....	323
11.3	Description of Disposal Work.....	33
12.	Complementary Documentsränzende Unterlagen	34

12.1	Drawings and Layouts.....	34
12.2	Foundation and Installation Plans.....	34
12.3	Spare Parts and Consumables	34
12.4	Electronic Documentation	34
12.5	Operating Manuals for the options.....	34
12.6	Test Reports.....	34
12.7	Service Address.....	34
13.	EC Declaration of Conformity.....	35
14.	Notes	36

1. Important Basic Information

1.1 Scope of Delivery

1.1.1 Basic Equipment:

- set of rollers
- electric control box
- display
- manual for operating instructions

1.2 Additional Equipment:

- remote control (infrared)
- pedal force meter
- simultaneous display (analog), several simultaneous displays possible via bus system
- digital display "Sherlane"
- printer
- weighing unit with four dynamometers per set of rolls
- heater of control box
- heater of set of rolls
- PC converter box with software „SharlanePC“
- radio pressure converter
- automatic all-wheel drive detection
- ASA-Livestream Set

1.3 Responsibilities of the Manufacturer in accordance with:

- Machinery Directive 2006/42/EC of May 17, 2006
- EMC Directive 2004/108/EC of December 15, 2004
- Low Voltage Directive 2006/95/EC of December 12, 2006
- Directive VkbI. (official gazette of the Federal Ministry of Transport, Building and Housing in Germany) 2003 / p. 303 for the operation, condition and testing of brake testers
- EC Directive CE marking
- DIN EN 60204-1 electronic equipment of the machines
- GS-EM I 04 - 01 and BGR (the German Federal Institute for Geosciences and Natural Resources) 157 auditing standards for machines and devices responsible for vehicle maintenance and for testing vehicles
- EC-declaration of conformity

1.4 Responsibilities of the Operator

- The machine may only be installed by competent and qualified personnel.
- The machine may only be used in accordance with its intended purpose.
- This operating manual must be read carefully in its entirety before commissioning the machine. Keep these instructions within reach at all times.
- Personal injuries which are a result of the non-compliance with this operating manual are not covered by the Product Liability Act.
- Sherpa does not assume liability for any damage to the test unit or the vehicle that was caused due to non-compliance with this operating manual.
- Safety guidelines warn of potential risks and help to avoid personal injuries and damage to properties. For your own safety, it is imperative that you adhere to the safety guidelines set out in this manual.
- The national and international safety regulations applicable in the respective country of operation must be adhered to at all times. Every operator himself/herself is responsible for complying with the regulations applicable to him/her and for obtaining independently the respective current regulations.
- The operating manual is part of the machine.
- The operating manual must be maintained and updated throughout the entire service life of the machine.
- The operating manual must be forwarded to any subsequent owner of the machine.

1.5 External Interfaces

- Interfaces for computer connection

1.6 Legal Information

1.6.1 Limitation of Liability

- Our liability is limited to the foreseeable damages typically occurring under the contract. We shall only be held liable for damage caused deliberately or due to gross negligence.
- The above limitation on liability does not apply in the event of injury to body or health.
- Any entitlement to damages expires regularly, two years after the time that it became justifiably clear that damage had occurred, or at the latest ten years after the damage occurred.

1.6.2 Warranty

- We warrant that our products are free from defects for a period of 12 months from the date of delivery to the purchaser. This does not apply for the delivery of used products. Any warranty is excluded here.
- Within the scope of the warranty, we are entitled to limit our responsibilities to provide a remedy and/or a replacement delivery at our own discretion.
- We accept no liability for any consequential damage or lost profits.
- All parties to the contract reserve the right to rescind the contract in the case of any unsuccessful attempt to remedy defects and/or any impossible replacement delivery.

1.7 Documentation







1.7.1 Operating Instructions – in accordance with DIN EN 62079

- The following documents, if not already included in the operating manual, are at your disposal:
- Operating Manual: option „automatic all-wheel drive detection“
- Remote control Mechoscreen – brief instructions
- SherlanePC operating manual
- mounting and installation instructions
- electrical circuit diagram
- maintenance and service instructions (including the Calibration Manual and the test report of the routine test)
- list of spare parts

1.8 Conventions

1.8.1 Illustration

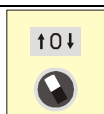
front axle 	parking brake 	rear axle 	entire weight 	printout 
---	--	--	---	---

left 	right 	confirm 	select device 
 - direction of rotation and measurement reversal of the rollers	 automatic button toggle function for „automatic ON or OFF“ and STOP		

1.8.2 Abbreviations

BPS	brake tester	e-motor	electric motor
L / R	left / right	kW	kilowatt
kN	kilo Newton	kg	kilogram
km/h	kilometres per hour		
LED	digital indicator light		

1.8.3 Technical Terms

SB	service break	FSB	parking brake
PM	pneumatic charge pressure	PX	pneumatic brake cylinder pressure
DMS	strain gauge		

2. Safety

2.1 Safety guidelines

- According to the manufacturer's declaration the "PRINCIPLES about testing the safety of roller brake testers and roller dynamometers" (GS-EM I 04-01), as well as the auditing standards for machines and devices responsible for vehicle maintenance and for testing vehicles (BGR 157) were taken as a basis during the production of the brake tester.
- This operating manual must be read carefully in its entirety before commissioning the machine. Keep these instructions within reach at all times.
- Personal injuries which are a result of the non-compliance with this operating manual are not covered by the Product Liability Act.
- Sherpa does not assume liability for any damage to the test unit or the vehicle that was caused due to non-compliance with this operating manual.
- Safety guidelines warn of potential risks and help to avoid personal injuries and damage to properties. For your own safety, it is imperative that you adhere to the safety guidelines set out in this manual.
- The national and international safety regulations applicable in the respective country of operation must be adhered to at all times. Every operator himself/herself is responsible for complying with the regulations applicable to him/her and for obtaining independently the respective current regulations.

 Gefahr	Danger: If instructions are not followed carefully or not complied with, the personal safety can be put at risk.
---	--

 Achtung	Warning: If these instructions are not followed carefully or not complied with, the device might be damaged.
---	--

 Hinweis	Please note: Additional information will be provided.
--	---

2.2 Behaviour in the case of an emergency

- In the case of a dangerous situation or an emergency, the test stand must be shut down by means of the main switch (emergency stop function) at the electric control box.

2.3 Purpose and Use

- The roller brake tester can be used to test the brake systems of two-track vehicles.
- The test stand may only be used in accordance with its designated purpose and within its performance limits.
- The measured brake force is indicated separately for each wheel.
- The test stand is not designed for testing all-wheel drive or multi-axle vehicles. However, all-wheel drive vehicles can be tested on some conditions.

2.4 Requirements for the Personnel

- The test stand may only be operated by authorized qualified personnel.
- The test stand may only be operated by trained qualified personnel.

2.5 Health and Safety at Work

- **main switch:** A lockable main switch (emergency switch) is available.
- **sensor rolls:** The test unit only starts if both sensor rolls are pushed down within 2 seconds
- **step protection:** protection sheets are installed beneath the sensor rolls.

2.6 Safety-relevant environmental conditions

- The V-shaped slot between the rollers must be secured by a cover or an elevated step protection.
- If the repair pit is under construction and the test unit in operation, no person is allowed to stay in the area below the vehicle.
- Depending on the national regulations, the repair pit must be covered or secured by other means for access.

2.7 Assembly and Disassembly

- see "assembly, installation, initial commissioning"

2.8 Disposal

- The transmissions of the driving engines are filled with oil which must be disposed of separately.
- Electronic circuit boards must be disposed of separately.
- This also applies for remote controls and printers.
- Sheet metal and iron parts are scrap metal.

2.9 Compliance with the Operating Manual

- The operating manual must be complied with at all times.
- The operating manual must always be kept close to the machine and be available to the entire personnel of the machine at all times.
- If applicable, the operating manual must be forwarded to any subsequent owner of the machine.

2.10 Safety markings on the machine

- The roller sets of the testing facility must be marked with circumferential warning markings on the floor or be secured by a barrier.
- The option "automatic all-wheel drive detection" is indicated on the control box.

2.11 Remaining risks and safety precautions

- Between the drive rollers is a V-shaped slot in which the sensor roll moves. Depending on the set-up area of the test unit, the test unit must be covered or fenced off to prevent access.
- If the drive rollers are elevated, there is a risk of tripping over.
- The test unit is equipped with rollers which are independently driven by electric motors. While the rollers are spinning nobody is allowed to be in the direct vicinity of the rotating rollers.
- After the vehicle has been driven onto the test stand, shift into neutral to disconnect the power flow to the drive axles.
- No parts or wheels must be parked on or between the test rollers.

3. Technical Information

3.1 Identification:

- The complete equipment of the test unit is identified by a type label on the control box as well as by means of the following information on the roller set:
- manufacturer -type and version -serial number - year of manufacture
- power in kW -power supply in V and ACNPE -current consumption measured in A
- In addition, each unit (set of rolls, display, print box, etc.) has its own serial number.

3.1.1 The entire system

permissible humidity		up to 85 %
operating temperature		-10° to +60°
point zero adjustment when ready for operation		every 2 minutes

3.1.2 Display cabinet

housing dimensions width x depth x height (mm)		810 x 670 x 70
weight		10 kg
braking force display		0 - 6 kN (0 – 12)
diameter of the needle-analogue display		400 mm
subdivision		180°
smallest increment		100 N
type size		25 mm

3.1.3 Control box

power supply		3 x 400 V (AC)
permissible fluctuation of the nominal voltage		± 10 %
protection		3 x 20 Ampere slow
supply lead		5 x 2.5 mm ²

3.1.4 Set of rolls compact

	3.0	3.5	6.0
one-piece frame width x length x depth (mm)	2260 x 580 x 195	2320 x 680 x 240	2925 x 680 x 240
approx. weight in kg	290	440	640
length of rollers in mm	600	700	1000
diameter of rollers in mm	167	205	205
track gauge	820 x 2160	800 x 2200	800 x 2800
distance between the axes of the rollers	380	410 mm	400
crossing capacity on middle cap, max. wheel load in kg	550	550	550
test speed in km/h	2.7	4.8	4.8
coefficient of friction dry / wet	0.9 / 0.7		
measuring system, shear force transducer DMS	with integrated measuring reinforcement		
noise emission LWA	<70 dB (A)		
welded roller surface	welding rod		
measurable axle load (for a deceleration of 50%) in kg	2000	2000	2450 / (4800)
measurable axle load (option of 2x4 kW motors) in kg		2450	
max. axle load on rollers in kg, when vehicle enters the test stand	3000	4000	5000 / (6000)
output of the driving engines in kW	2 x 2.4	2 x 3 kW	2 x 4
voltage supply in mm ² / A	5 x 2.5 / 16	5 x 2.5 / 20	5 x 2.5 / 20

4. Description of the System

4.1 Range of application

- The roller brake tester can be used to test the brake systems of one- and two-track vehicles and has a certification for the vehicle inspections in accordance with § 29 StVZO (German road traffic licensing authority) in relation with appendix VIII main inspections.
- The right and left brakes will be inspected independently.

4.1.1 Requirements in accordance with Directive 10/2011

With effect from October 01, 2011, only roller brake testers with the following option will be allowed in Germany, in accordance with the directive 10/2011 for vehicle inspections in accordance with § 29 StVZO.

- The minimum diameter of the test rollers is 200 mm.
- slip measurement with additional speed sensors on sprocket wheels
- For vehicles of the category M1 or N1 (below 3.5 t in weight permitted), the minimum test speed is 4 km/h. For test stands with a lower test speed, the option "two test speeds" is available.
- ASA-Livestream interface

SVZ	210142	ASA-Livestream Set for Sherpa-BPS (in accordance with Directive 10/2011 Germany) Scope of Delivery: Converter for BPS control box (RS 485 with USB port), speed sensor for brake rollers	
-----	--------	--	---

4.1.2 ASA-Livestream Set

- In the control box is a cable with an integrated **ASA-Livestream converter**. One end of this cable is connected to the RS 485 interface (connector for all kinds of displays) and the other end has an USB plug for the data transport to the external computer.
- In addition to the two speed sensors at the sensor rolls, two speed sensors are installed at the sprocket wheels.

With the option "ASA-Livestream Set" Sherpa's test stands of the type range BPS-Kompakt-3.5 to 13.0 and BPS-Twin are in accordance with the Directive 10/2011.

4.1.3 Vehicles with or without the option to disengage the all-wheel drive system

- can be tested.

4.1.4 Vehicles with a permanent all-wheel drive

- The following requirements determine whether it is possible to test all-wheel drive vehicles whose wheels, which are mounted on one axle, can each be rotated in the opposite direction.
- Whether all-wheel drive vehicles can be tested, depends on some conditions.
- All-wheel drive vehicles with a low power transmission or whose all-wheel drive system can be disengaged in the test stand can be tested (also see the manufacturer's note in the manual about the test procedure in relation to the integrated automatic start-up monitoring).
- All-wheel drive vehicles with a high rate of power transmission (rigid or "quasi rigid" drive system) during the brake test cannot be tested.

4.1.5 Automatic all-wheel drive detection (option)

- For a brake test in which multi-axle vehicles are tested on roller brake testers, it is common practice to enter the test stand with the wheels of one axle to rest between the test rollers and to evaluate the brake force of the two wheels spinning forwards.
- For all-wheel drive vehicles with a rigid or quasi-rigid drive system serious problems can occur.
- Depending on the amount of power which is transmitted to the wheels, the vehicle is driven out of the test rollers by means of the other driving axles, or an increased rolling resistance acts on the axle which is to be tested as a result of the intervention of the all-wheel system. This increased rolling resistance can highly distort the measuring results of the brake test.
- For vehicles with a **multi-axle drive**, the brake force of any wheel brake can be transferred to the other wheel brakes via the drive train depending on the drive system. However, if the wheel brakes of passenger cars or trucks are tested, the brake force of the individual wheel brakes is to be evaluated, not the transmission of the brake force via the drive train.
- In order to reduce these forces it has been common practice for a long time to test the wheels of

the axle which is to be tested in such a fashion that one side is turning forwards and the other side backwards.

- Due to the great number of the most diverse all-wheel drive systems, it has become very difficult for the skilled person in this field to recognize at once which type of test needs to be carried out for the respective drive system – either both wheels on the axle turning forwards or reverse the direction of rotation on either side.
- Due to our new system the operator does no longer need to make a decision. This system automatically recognizes at the start of the test if the vehicle's driving axles can rotate freely or if they are connected to an all-wheel drive system.
- For a vehicle with a **single-axle drive**, both wheels on the roller brake tester start spinning in one direction and if the vehicle is set in idle condition, the drive shaft can rotate freely without transmitting power to the wheels. If the axle shafts of the axle which is connected to the drive wheels are slowed down by the drive shaft, as it is the case with an **all-wheel drive system** or an engaged gear, the differential of the axle causes the opposite wheel to turn in the other direction.
- One side of our test stand starts, as a rule, slightly earlier or later than the other, whereas the left wheel starts turning forwards. If the drive shaft is forced to slow down, the right wheel will turn one revolution in the opposite direction, which will immediately be detected by the brake force measuring system. Then the right wheel automatically starts turning in the opposite direction and the display automatically shows a positive measured value.
- As most "all-wheel drive vehicles" are equipped with disc brakes, the pedal force meter is not necessary to measure the difference of the brake force in reverse direction of rotation. The difference between the brake force of the disc brakes rotating forwards and backwards is very small.
- **The time in which the vehicle is being tested is the same as for single-axis driven vehicles.** Slightly more time will be needed only if the test unit automatically carries out a cross-check.
- If the braking force imbalance is too high, another check is carried out in the reverse rotational direction. In this case the two values of the braking force imbalance of both checks are compared with each other. The threshold value for the cross-check can be saved in the program.

4.2 Main Component

- The standard equipment of the test unit includes a self-contained or a two-part roller set, a control box and a moving-needle analogue display or a PC converter box.

4.2.1 Set of rollers

- The standard roller sets are hot-dip galvanized.
- **The roller sets** are available as **self-contained or two-part models**. A two-part set is mainly used for test stands on a repair pit.
- **The self-contained roller set** is a compact unit which is equipped with four rollers and a drive and measuring unit in the middle area of the test stand which includes gear motors, sprocket wheels, a chain and a DMS sensor.
- **The two-part roller set** contains two roller sets with two rollers each and a drive and measuring unit which is mounted on the side.
- **The pairs of rollers** are each driven by an electric motor which is mounted on swivel bearings and can transfer the occurring torsional forces to a bending beam.
- **The bending beam** has a DMS sensor which forwards the measured values to the printed circuit board in the control box for the electronic measured value processing.
- **The rollers** are made of steel pipes with a welded-on profile.
- Sensor rolls are built in between the rollers. The sensor rolls are mounted in swivel bearings and are pushed down by the wheel and pulled up again by a spring after the vehicle has left the test stand. By means of proximity switches the situation for "vehicle in test stand" or "test stand empty" can be recognized and the test stand can be started and stopped in automatic mode.
- The rotational speed of the wheels is measured by means of the rotating sensor rolls. If the difference between the rotational speed of the wheels and the input speed is about 25% (slip), the test stand will be switched off for safety reasons.



- **The roller sets** only rest on the set screws which are attached to the four corners underneath. By this means the roller set can be adjusted in height up to minus or plus 10 cm. In order to prevent the set screws from being in direct contact with the concrete underneath, the roller set comes with metal sheets. These contact sheets have to be attached to the side of the foundation by means of dowels.
- **The option weighing unit** includes sensors which are attached next to the screw holes. In this way the set screws can be screwed into the sensors.
- **To prevent the roller sets from slipping**, the roller sets are firmly attached to the foundation by means of adjusting screws at the side. **If the weighing unit is in operation**, the roller set must not be attached to the foundation firmly but built in leaving a small gap between the set screws and the foundation wall.

4.2.2 Control Box

- **The control box is the brain of the test unit.** There are printed circuit boards, contactors, the main switch (emergency switch-off) and other switches or buttons in the control box. See operating manual.
- For this reason **the control box** should be mounted in the direct vicinity of the roller set.
- The analogue displays, the PC converter box and the print box are connected to the control box.
- The whole data transfer happens in **the bus system**.
- **Self test / zero balance:** A permanent self test is carried out by all safety-relevant components (sensors and electronics) ready for operation. A drift in temperature in force transducers will be compensated for by a dynamic point zero adjustment. This adjustment is carried out regularly every 2 minutes when the force transducers are not in use and ready for operation.
- **Natural frequency / attenuation:** The measuring steps are smaller than 1 % of the final measuring range value.
- **Functional defects:** Functional defects are recognized and illustrated by the electronics. They can be identified with the help of the error checklist. (see operating manual)

4.2.3 Illustration and printout of the measurement results

- **The moving-needle analogue display** consists of two neighbouring displays indicating the braking force for left and right respectively. It can be used either as a master or a simultaneous display.
- **For the PC converter box** which uses the „SherlanePC“software, an external PC unit including a display is necessary.
- **Printing** can be achieved via the PC unit or by means of the option "print box" via a separate, conventional printer. After the completion of the test procedure in every operating mode (see section 3.12), use the computer keyboard or the remote control to print.

4.3 Modes of Operation

4.3.1 Manual Operation

- manual control of the test unit by means of the remote control (infrared) or by means of a button on the control box

4.3.2 Automatic Mode

- automatic test run start

4.3.3 Option of direction of rotation and measurement reversal

- With this option it can be preselected by means of the switches at the control box if the wheels are to be turned in the same direction, i.e. forwards or backwards, in opposite directions or if only one wheel is to be rotated.

4.3.4 Automatic all-wheel drive detection:

- In this operating mode (right and left switch are set to the position "0") the test stand recognizes if there is a transmission of power between the left and the right wheel. If the wheels which are attached to one axle cannot turn independently, the test stand automatically changes over to reverse mode of direction of rotation (left forwards / right backwards). During this type of testing the green LED flashes to indicate that the test stand is in operation.
- If the difference of the maximum brake values is higher than 15 % from left to right, the green LED continues flashing and a cross-check in reverse mode is carried out.
- After the LED stops flashing, the brake values of the wheels turning forwards and the corresponding difference will be displayed.
- Note: The value of the braking force imbalance for the cross-check in reverse mode can be customized in the calibration mode.

5. Installation Requirements

5.1 Installation

5.1.1 Main Components

- set of rollers
- control box
- display

5.1.2 Operators' Workplaces

- test stand
- office

5.2 Functional Description

- The roller brake tester can be used to test the brake systems of two-track vehicles and has a certification for vehicle inspections in accordance with § 29 StVZO in relation with appendix VIII main inspections
- The right and left brakes will be inspected independently.
- The pairs of rolls are each driven by an electric motor which is mounted on swivel bearings and transfers the occurring torsional forces to a bending beam.
- The integrated microprocessor control evaluates the measuring results.
- The rotational speed of the wheels is measured by means of the rotating sensor rolls. If the difference between the rotational speed of the wheels and the input speed is about 25% (slip), the test stand will be switched off for safety reasons.

5.3 Description of the Process

5.3.1 Set of Rollers

- Depending on the version, the roller set is available as a self-contained or a two-part model. Two-part roller sets are primarily used when installed on top of repair pits. Depending on the national regulations, safety elements are required for securing the pit during the construction of the pit.
- Depending on their design, self-contained roller sets can be mounted into a foundation or at floor level with ramps. If the roller set is installed at floor level, access and exit ramps are required.
- The roller set is pre-wired and has to be connected to the control box.
- The display units are to be connected with the control box.

5.3.2 Control Box

- The main power supply must be on site where the control box has been installed.

5.4 Display Units

- The display units are connected to the control box.

5.4.1 Moving-needle analogue display

- The moving-needle analogue display is equipped with a retaining clip. It can be mounted on a foot or attached to the wall by means of wall brackets.
- It must be mounted in such a fashion that it can clearly be seen when sitting in the vehicle.

5.4.2 PC-Display Units

- In general, the information defined by the manufacturer of the PC display needs to be followed.
- When operated in connection with a needle display, the PC display can be mounted somewhere out of sight of the vehicle, up to a distance which is in range of the customary connection devices.
- Without any needle display the PC display should be mounted in sight of the testing area.

5.5 Assembly Site

5.6 Delivery and Installation Requirements of the Test Stand

- The location where the test unit is to be installed must be well accessible for transport vehicles or equipment.
- For unloading, moving and inserting equipment on the assembly or erection site, a mobile mechanical lifting equipment, which can carry the weight of the test unit, must be provided by the client.
- The client shall ensure that the installation site is not surrounded by a hazardous environment.

5.6.1 Foundation and Floor

- Requirements for the foundation and the floor load capacity is specified in the corresponding foundation and installation plans.

5.6.2 Environmental Conditions

- The test stand can also be operated outdoors and meets the requirements of the IP 54 protection rating (dust and splashing water protected). It is designed for the operating temperatures of minus 10° C up to 60° C.
- The roller set must not be under water.
- For the force transducer, the manufacturer of the component specifies a susceptibility to a temperature of $\leq 0.04 \text{ \%}/\text{K}^\circ$ (for a temperature of $> 22^\circ \text{ C}$) of the final calibration value or the nominal value to be measured.
- When operated outdoors, a roof construction is required as stipulated by the manufacturer of the display unit. If used at temperatures of minus 0° C and surrounded by snow, a heater is required for the set of rolls.

5.6.3 Power supply leads

- The main power supply has to be on site where the control box has been installed.
- For some options, an air connection is also required.
- The range of power of the supply leads is specified in the corresponding foundation and installation plans.

5.7 Installation Plan

5.7.1 Set of Rollers

- Depending on the version, the roller set is available as a self-contained or a two-part model. Two-part roller sets are primarily used when installed on top of repair pits. Depending on the national regulations safety elements are required for securing the pit during its construction.
- Depending on their design, self-contained roller sets can be mounted into a foundation or at floor level with ramps. If the roller set is installed at floor level, access and exit ramps are required.
- The roller set is pre-wired and has to be connected to the control box.
- The display units are to be connected with the control box.

5.7.2 Control Box

- The control box should be mounted in the direct vicinity of the roller set.

5.7.3 Moving-needle analogue display

- The operator should have a good view on the display unit from the position of the vehicle during the entire testing operation.
- The needle display can be erected outdoors; however, it must be protected from wind, water and damaging environmental impacts.

5.8 Entire Space Requirement

- How much space is required for the entire equipment depends on the size of the vehicles which are to be tested.

5.9 Dimensions and Weights

- see technical documentation

6. Assembly and Installation, Initial Commissioning

6.1 Assembly Requirements

- The test stand can only be assembled and installed if the temperature and environmental conditions are tolerable and if adequate working conditions apply.
- Safe working conditions must be provided on the assembly site.

6.2 Safety

- The test stand may only be installed by competent and qualified personnel.
- The set of rolls is equipped with a step protection underneath the sensor rolls.
- The middle cover of compact test stands can carry a maximum load of 500 kg.

6.3 Assembly and Installation

6.3.1 Display cabinet

- Mount the needle display at the designated location.
- For outdoor operations, a roof construction is required.
- Connect the power supply cord with the European-style terminal strip which has three contacts and run the cord to the control box.
- Connect the bus cable with the PCB of the display unit and run it to the control box.

6.3.2 Screen

- The test unit can be operated using either one moving-needle analogue display or a computer with a screen or both at the same time.
- If the computer and the screen are used, please follow the information specified by the manufacturer of the computer and our **operating manual "SherlanePC"**.
- For the data transfer from the test units to the PC, the option **"PC converter box with the Sherlane test lane software"** is necessary.
- One side of the PC converter box is connected to the control box and the other one with the serial interface at the computer.

6.3.3 Control box

- The control box must be mounted near the set of rolls.
- Connect the supply lead with the main switch in the control box.
- Connect the bus cable of the display with the PCB of the control box.
- Connect the power supply cord of the display with the terminal strip.

6.3.4 Set of Rolls

- Disassemble the middle cover of the roller set and heave it to the side.
- The upper side of the roller set has threaded slots into which eyebolts can be screwed. The set of rolls is attached to these eyebolts and hoisted into the foundation by means of mechanical lifting equipment.
- Large arrows are attached to the roller sets which indicate the main driving direction. The roller sets must be mounted in the main driving direction, even if the optional directional rotation and measurement reversal is available.
- Hoist the roller set into the pit and use the set and adjusting screws to adjust the height and to firmly attach it to the foundation.

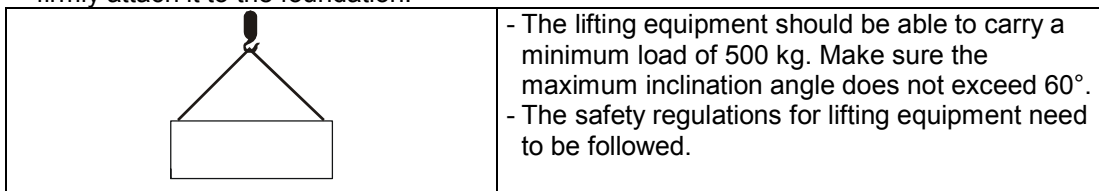

- Run both engine cables to the control box and connect them with the power contactors.
- Run both sensor cables to the control box and connect them with the PCB of the control box.
- Reinstall the middle cover of the roller set.

6.4 Calibration device in accordance with ISO 17025

- see 10.3.2

6.5 Initial Commissioning

- Follow the operating instructions.

6.6 Option lifting/lowering device

SVZ	210085	- Pneumatically operated lifting/lowering device; if it is employed as a step protection, a vehicle with a maximum axle load of 4 t is allowed to drive over it. - the lifting/lowering device is automatically lifted or lowered due to weight recognition
SVZ	210085	- The pneumatically operated lifting/lowering device has a lifting force of up to 2.2 t, - It can carry a load of 4 t when the vehicle is driven over the test stand; manual lifting and lowering operation is carried out by means of the automatic button at the control box (or by means of the option "remote control radio").

6.6.1 Description / Installation

- The lifting/lowering device is a completely separate component which needs to be attached to the set of rolls. If older test units are upgraded, 4 holes need to be drilled beneath the set of rolls on each side in order to screw the lifting/lowering device to it.
- The lifting/lowering device is equipped with an air ram which lifts and lowers the device. In the middle of the roller set a pneumatic valve which controls the air rams is installed. The pneumatic valve is controlled by the PC board of the control box.
- The air supply line is connected to the pneumatic valve. Its supply pressure needs to be between 6 and 9 bar but if it is higher, a pressure limiter needs to be installed.

6.6.2 Application

- The V-shaped slot between the rollers is covered by the "lifting/lowering device" in standby mode. This provides us with a safety device which prevents people who walk around this area from tripping over the brake rollers.
- If a vehicle is driven over a **standard test stand**, its wheels will rest in the V-shaped slot between the rollers and consequently cause a noise which is perceived as unpleasant by some users. If the lifting/lowering device is elevated, a vehicle of about 4 t can be driven over the V-slot cover without its wheels sinking in between the roller set completely. By this means, the vehicle can be driven over the test stand without causing any noise.
- Vehicles with a low ground clearance and spoilers are gently lowered into the V-shaped slot by means of the lifting/lowering device. This prevents spoilers and low vehicle components from being damaged.

6.6.3 Description

- **If the lifting/lowering device is used as a step protection**, it is not responsible for lifting the vehicle's wheels out of the gap between the rollers. This would significantly extend the time in which the vehicle is being tested and require a manual operation via an actuating switch or a remote control.
- The vehicle can easily be driven out of the set of rollers, as we have installed a standard auxiliary drive-off system which prevents the rollers from over-speeding at all times and hence facilitates driving out of the test stand. The set of rollers is equipped with a weight sensor and can identify the axle weight of the vehicle after an adjustable time delay and the weight has been set and automatically lifts or lowers the **"lifting/lowering device"**. Therefore, any manual operation becomes unnecessary.
- **The lifting/lowering device can lift** the wheels out of the V-shaped slot between the rollers with a lifting force of 2.2 t axle weight. It is manually operated by means of the radio remote control "Radio"
- The lifting/lowering device is operated pneumatically with a maximum pressure of 6-9 bar and is controlled electronically. The standard time needed to lower the wheels is about 3 seconds and can be customized by means of a throttling valve (optional).
- Please Note: If the test unit is turned off and compressed air is still in the system, the lifting device remains elevated.
- If the air pressure is less than 2 bar, the outlet valve will not open anymore. If necessary, the air supply line needs to be disconnected from the pressure switch/ automatic button.

6.7 Option Remote Control

6.7.1 View

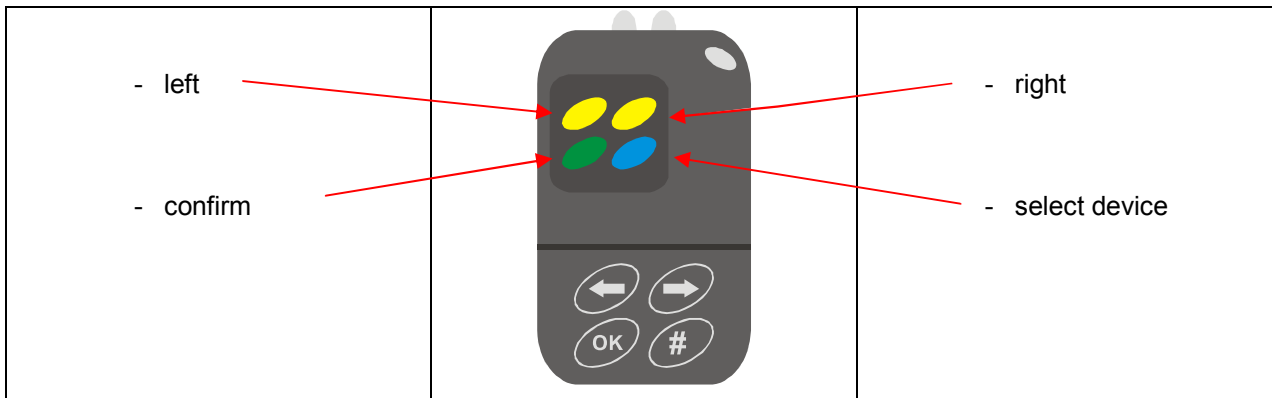

6.7.2 Description of the Symbols

- left	- right	- confirm	select device
			

6.7.3 Initial Commissioning

- The remote control has a rechargeable battery. Between the contacts of the battery is a protection foil which needs to be removed before it can be operated.

6.7.4 Functions

- see separate operating manual

7. Operation

7.1 Safety

7.1.1 Safety Devices

- The lockable main switch can also be used as an emergency off-switch
- automatic button with pre-selection for a manual or an automatic start of the test stand
- **Automatic start of the test stand:** In the automatic operating mode, both sensor rolls must be pushed down at the same time within 3 seconds, then the test stand starts with a time delay of about 5 seconds. The test stand can be set in such a way that both rollers start at the same time or consecutively with a time delay.
- **Automatic start-up monitoring:** The test stand detects wheels which turn with difficulty or which are locked up and automatically shuts down after the test has been started. After about 5 seconds the test stand attempts to start again. The reason for wheels which rotate with difficulty or are locked up can be an engaged gear, a pressed brake pedal, an actuated parking brake, an all-wheel drive system or a defect on the brakes, bearings or else. If the test stand shuts down again, the vehicle must be driven out of the set of rollers and the reason for the difficulty of rotation must be inspected.
- **Automatic standby-mode switch-off:** If the test stand has started and no braking test has been carried out for a longer period of time, the test stand automatically switches to manual mode.
- **Automatic slip switch-off:** The sensor rolls monitor the difference in the speed of rotation between the wheels and the drive rollers. If a certain slip value is exceeded, the test stand automatically shuts down. The slip limit is adjustable. The parameterization of this value is only to be carried out by the authorized service personnel.
- The test stand also automatically shuts down if the load on the driving engines becomes too high and the input speed drops under the pre-set slip value.
- **Automatic restart:** In the automatic mode, the test stand is switched on again each time after the sensor rolls have been pushed down for about 5 seconds.
- **Automatic shut-down after the vehicle left the test stand:** If the vehicle is driven out of the test stand and the sensor rolls move upwards, the test stand automatically shuts down.
- **Automatic auxiliary drive-off system:** If the test stand is driven by the drive wheels of the vehicle and hence the test speed of the test stand is exceeded, the electric motors of the test stand are automatically engaged. This prevents the rollers of the test stand from over-speeding and makes it easier for the vehicle to be driven out. Additional power of the motors is provided in all modes of operation, as long as the test stand is active and is connected to the power supply.

7.2 Operating Elements

7.2.1 Control Box

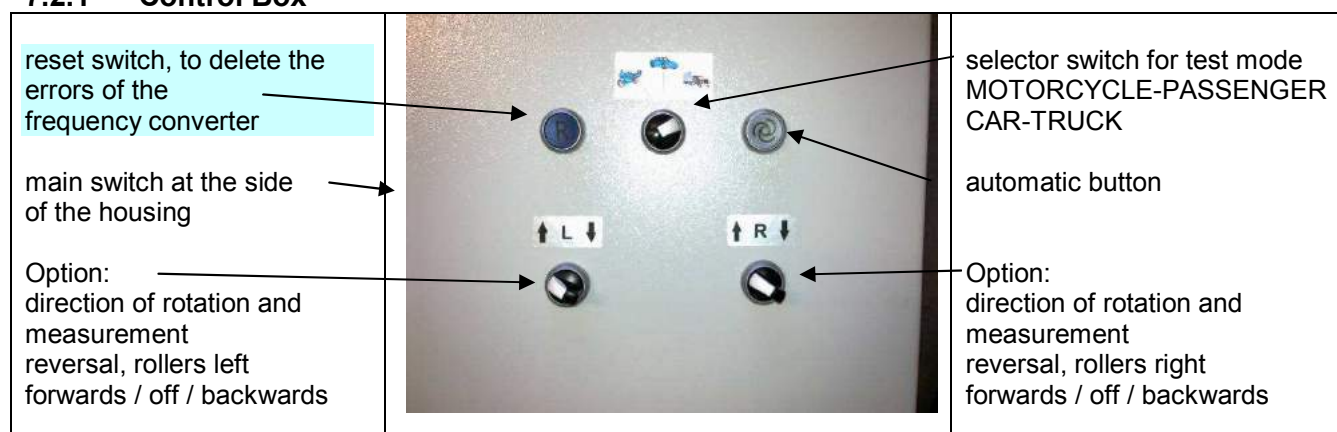



Option: direction of rotation and measurement reversal, both rollers rotate in the same or in opposite directions and single wheel changeover, operation at the control box

- By means of this option, each side of the drive rollers can be rotated forwards and backwards or even turned off. By this means, not only the direction of rotation but also the direction of measurement will be reversed automatically.
- The extended option “**automatic all-wheel drive detection**” is activated if both switches are in middle position.

Option: Selector switch for preselecting the vehicle, testing a motorcycle, a passenger car or a truck

- By means of this option the test procedure, the visual illustration on screen and the printout can be preselected.

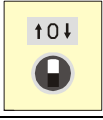
7.2.2 Description of the Symbols

	If the switch is in left position, the driving roller will rotate forwards.
	If the switch is set to 0 or L/R, the driving roller is turned off.
	If the switch is in right position, the driving roller will rotate backwards.

7.2.3 Functions: switch position left (1) middle (0) right (2)

- Both switches are set to 1: the direction of rotation and measurement is forwards.
- Both switches are set to 2: the direction of rotation and measurement is backwards.
- left switch is set to 1, right switch set to 2: the direction of rotation and measurement on the left is forwards, on the right backwards
- left switch is set to 2, right switch set to 1: the direction of rotation and measurement on the left is backwards, on the right forwards
- If one switch is set to 0: the corresponding driving engine is disengaged.
- Both switches are set to 0: both driving engines are disengaged.

7.3 Display Units

7.3.1 Illustration of the moving-needle analog display

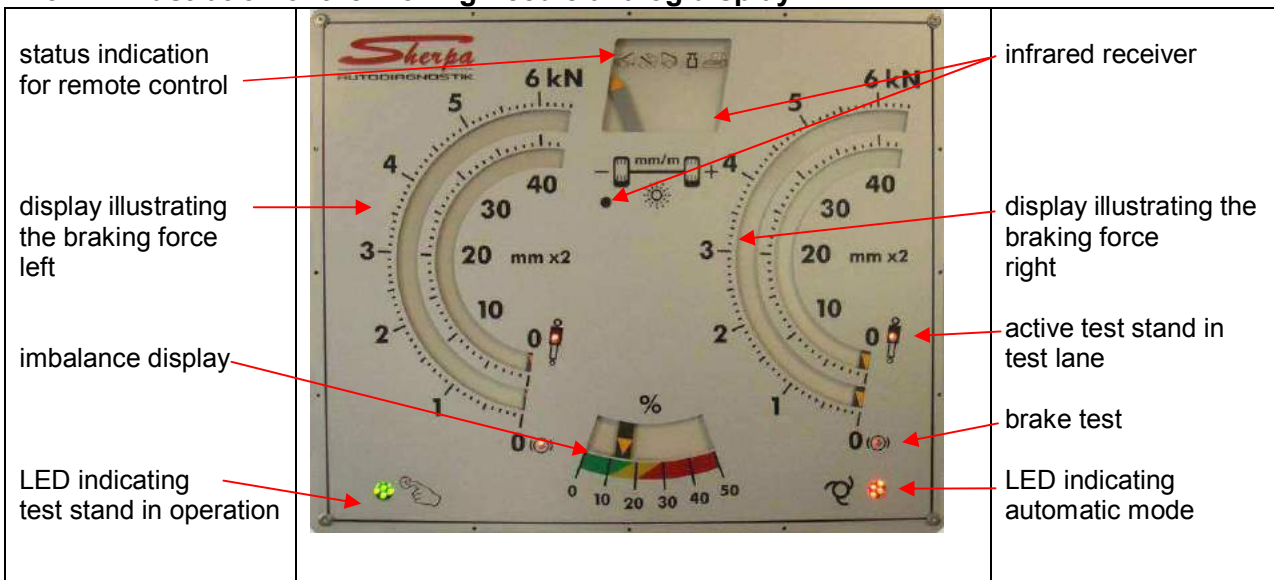

7.3.2 Option imbalance display (needle display)

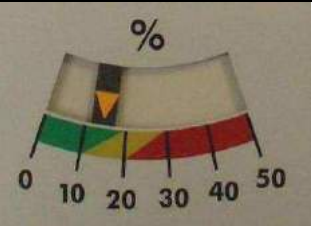
	<ul style="list-style-type: none"> - The needle display indicates the difference between the brake force of the left and the right wheel in percent %. - 0% ≤ green < 20% - 20% ≤ yellow < 25% - 25% < red - The difference is evaluated starting from 400 N and displayed.
---	---

7.3.3 Option imbalance display (LED display)

	<ul style="list-style-type: none"> - The LED indicates the difference between the brake force of the left and the right wheel in percent %. - at a difference of 20 % or higher the LED will light up - at 50 % or higher the LED flashes - The difference is evaluated from 400 N and displayed.
--	---

7.3.4 Option status indication and description of the symbols

	<p>front axle</p>	<p>parking brake</p>	<p>rear axle</p>
	<p>entire weight</p>	<p>printout</p>	

7.4 Operation of the Test Stand

7.4.1 Switching the test stand on

- Switch on the main switch, the green LED will light up to indicate the power supply. Everything is automatically set to zero.
- The test stand can be switched to manual or automatic start by means of the automatic button at the control box. After the main switch has been activated the test stand is in manual mode.
- Only after the automatic button has been pushed it will be switched over to automatic mode.
- **Please Note:** If the pointers of the displays indicating the braking values are not behind zero and the LED for "test stand in operation" or the automatic LED flashes, the error message is active. By means of the needle position and with the help of the error code list, the error which occurred can be analysed.
- **Please Note:** For the option „direction of rotation and measurement reversal“, have a look at the switch positions before driving into the test stand. Do not switch over abruptly while the test stand is in operation (possible damage to the vehicle or the test unit).
- **Please Note:** Before driving into the test stand, **please make sure that the ground clearance of the vehicle which is to be tested is high enough.**

7.5 Modes of Operation

7.5.1 Manual start of the test stand without a remote control (two-man-operation)

	<ul style="list-style-type: none"> - Automatic button at the control box - Toggle function for „ON or OFF“ and STOP
--	---

- Push the automatic button at the control box until the orange LED on the display turns off.
- When switching over from automatic to manual start and vice versa, no vehicle must be in the test stand.
- After switching over, drive the vehicle in the test stand in such a fashion that the wheels of the axle which is to be tested rest between the brake rollers.
- Another person can then start and also stop the test procedure by pushing the automatic button.

7.5.2 Automatic start of the test stand

	<ul style="list-style-type: none"> - Push the automatic button at the control box until the orange LED at the display lights up. - Toggle function for „automatic ON or OFF“ and STOP
--	---

- When activating the automatic test start no vehicle must rest in the set of rolls.
- The orange LED must flash continuously to indicate the automatic mode. Then the test stand is in automatic mode and starts automatically after the vehicle has been driven into the test stand.

7.5.3 Test procedure in general

- Drive the vehicle into the test stand with the axle which is to be tested in the centre, release the breaks, shift into neutral and hold the steering wheel with both hands. In the automatic start, the automatic LED starts flashing and the pointers are in zero position. In the manual start, one of the start buttons needs to be pushed.
- After about 5 seconds the test stand starts automatically. After the automatic start of the test stand, the automatic LED will go out. Releases the steering wheel until aligned and hold it again.
- Depending on the default settings both sides can start simultaneously or consecutively with a preselected time-delay.

- If the rolling resistance is excessively high (e.g. tension in the drive train of all-wheel drive vehicles, or the brakes were accidentally hit and act on the wheels etc.), the test stand is automatically turned off by means of the automatic start-up monitoring system which will attempt to start it again after about 5 seconds.
- If the start-up monitoring system interferes again, although the brake is released or the gears are put in neutral, the vehicle needs to be driven out of the test stand and the reason for the difficulty of rotation must be inspected.

7.6 Remote Control

- see separate operating manual

7.7 Motorcycle brake test (option)

- The test stand is also suitable for testing one-track vehicles.
- The options "roller cover for motorcycle test", "direction of rotation and measurement reversal" or "remote control" are required.

SVZ	210048	the cover for the rollers is galvanized and pluggable on the BPS-Kompakt- 3.5 test unit for the motorcycle test , a cover plate with a 300 mm recess for the wheel of the motorcycle, a spur-post, a maximum loading capacity of 2 t (only in combination with "direction of rotation and measurement reversal" or "remote control")
-----	--------	---

- By means of the options „**direction of rotation and measurement reversal**“ or „**remote control**“ the test stand can be operated in the single-wheel mode.
- The single-wheel test can only be operated manually.
- By pressing the automatic button on the control box, the mode of operation can be changed to **automatic or manual mode** if the sensor roll is not pushed down.
- For the safety of the operator, the **roller cover for the motorcycle** needs to be installed, leaving a recess of 300 mm to uncover the rollers.

7.7.1 Test procedure for motorcycle testing

- Set the test stand to manual mode.
- Drive the motorcycle into the recess of the roller cover in the V-shaped slot between the rollers.
- If the sensor roll is pushed down, the test stand can be started using the remote control or the automatic button.
- When the sensor rolls are rotating, engage the brake and read off the brake values of the display.
- Then drive out of the roller set.

7.8 „Automatic all-wheel drive detection" (option)

SVZ	210309	<ul style="list-style-type: none"> - Automatic all-wheel drive detection, automatic direction of rotation and measurement reversal in opposite directions and automatic test procedure (including the option SVZ 210314 „manual direction of rotation and measurement reversal“) - Patent application „Automatic all-wheel drive detection and Regulation“ (DE 102005047970.7 and PCT/EP2006/009490)
-----	--------	--

- The test units are equipped with a control box on which all operating switches or buttons are located.
- Switch on the main switch to start the test; the green LEDs on the displays light up to indicate the power supply. The test stand is ready for testing.

7.9 Electronic Control Box – General View

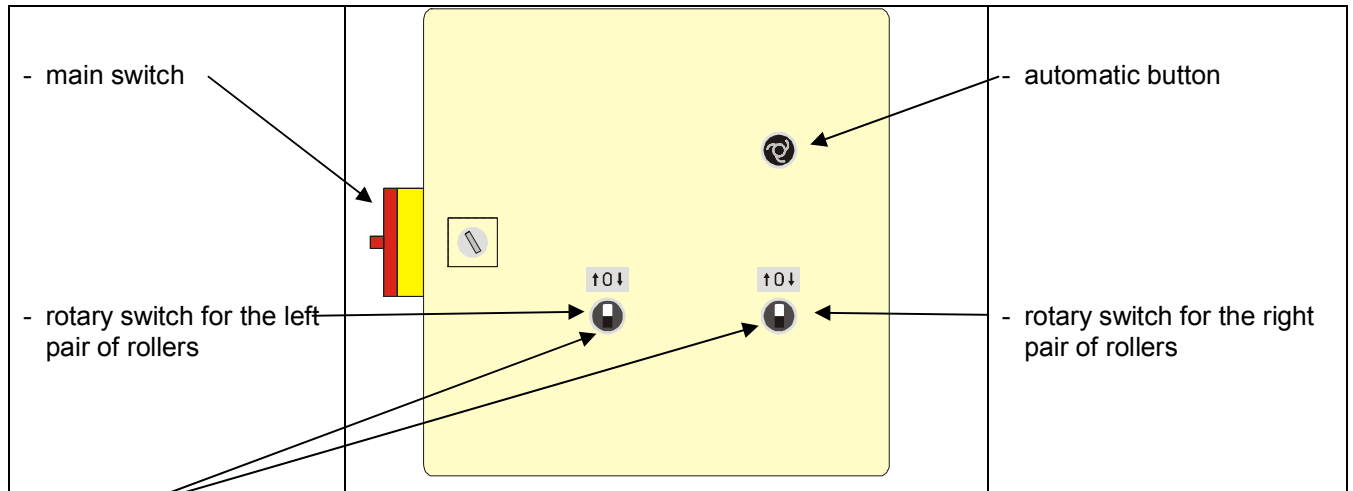

- **Both switches in middle position**, automatic all-wheel drive detection is active
- **Whenever one of the two switches is turned to another position** the automatic all-wheel drive detection is switched off and the test stand operates in the selected function.
- **The arrows next to the switches** indicate the direction of rotation and measurement of the wheels.

7.9.1 The possibilities are as follows:

- Both switches are turned to the arrows pointing up: both wheels will spin forwards
- Both switches are turned to the arrows pointing down: both wheels will spin backwards
- One switch is turned to the arrow pointing up and the other switch to the arrow pointing down: one wheel is spinning forwards and the other backwards
- One switch points to an arrow and the other switch is in middle position: single-wheel mode, one wheel is spinning in the selected direction and the other wheel remains stationary.
- By changing the direction of rotation, the direction of measurement is also changed.

7.9.2 Preparations

- For a test incorporating the automatic all-wheel drive detection, please make sure that the switches for the direction of rotation are in the middle position.
- If the automatic button is pushed, either a manual or an automatic start of the test stand can be selected.
- **In automatic mode**, the test stand automatically starts after a few seconds after the vehicle has been driven into the gap between the brake rollers and the sensor rolls have been pushed down.
- **In manual mode**, the test stand needs to be started manually by pushing the automatic button on the control box or by means of a remote control.
- If the automatic all-wheel drive detection is selected, the test always begins at the left side of the test stand and after a short delay the right side is started as well.
- If the drive shaft of the vehicle rotates with difficulty or cannot rotate freely, the test rollers of the right side of the test unit start rotating in the opposite direction (backwards).
- This will be indicated by the **flashing green LED on the needle display or the computer display.**

7.10 Test procedure for automatic all-wheel drive detection

- As long as the green LED flashes the automatic all-wheel drive detection is active. If the difference between both brake values is too high, the test stand carries out a cross-check with a reversed direction of rotation.
- If the slip limit has been reached, the test stand automatically shuts down.
- If the slip limit has not been reached, the brake must be released and after 10 to 15 seconds the test stand automatically shuts down.
- If the vehicle is lifted out of the test stand and the green LED flashes, the vehicle must enter the test stand again with the same axle to be tested.

Only when the green LED stops flashing for "in operation", the test procedure is finished and the vehicle can leave the test stand.

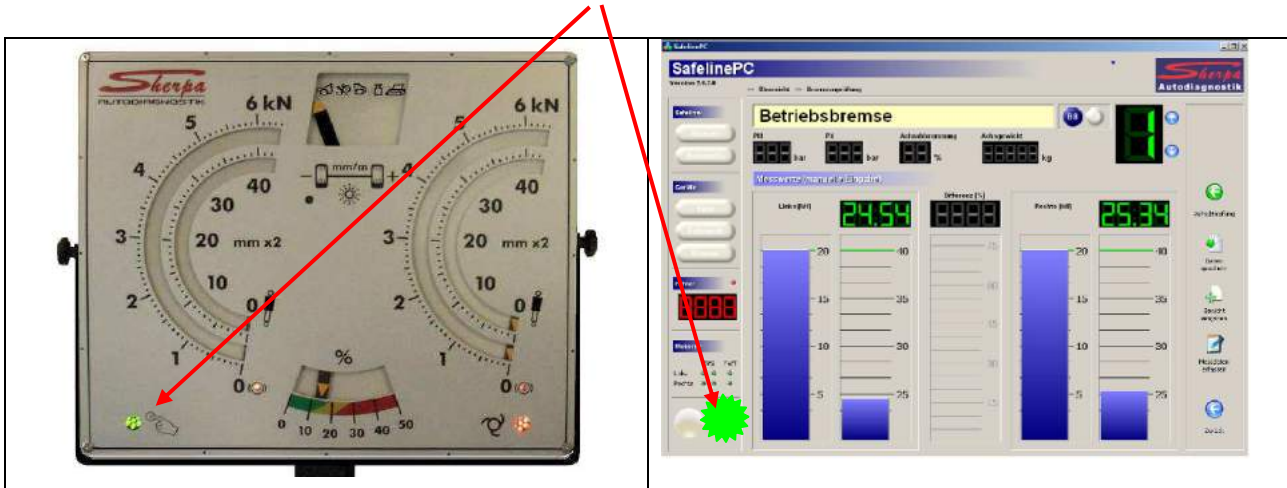

8. Brief Operating Manual

8.1 Start up the test stand

- Switch on the main switch, the green LED will light up to indicate the power supply. Press the automatic button, the test stand switches to automatic start and the orange LED lights up.
- Please make sure that the ground clearance of the vehicle to be tested is sufficient before entering the test stand.

8.2 Entering the test stand

- Drive the vehicle into the test stand with the axle which is to be tested in the centre, release the breaks, shift into neutral and hold the steering wheel with both hands. The orange automatic LED starts to flash and the test stand is started after about 5 seconds.
- After the test stand has been started, the orange LED will go out. Release the steering wheel until it is aligned and hold it again.

8.3 Brake Test

- Slowly engage the brake pedal or the parking brake and watch both displays indicating the increasing brake values.
- Continue to increase the brake values until the test stand is shut down by means of the slip switch-off. The display indicates the maximum brake value for about 5 seconds. During this time the orange LED flashes to indicate that the test stand is in automatic mode, then the test stand will be restarted and the orange LED will go out.
- Carry out the braking process again or exit the test stand.

8.4 Leaving the test stand

- Shift into first gear and drive the vehicle out of the test stand while the green LED is lit up.

Please Note: Do not leave the test stand if the orange LED is flashing, as the test stand is not active yet and as a result the wheels of the vehicle are not supported by the test rollers when driving out. After the orange LED has gone out, the electric motor of the test rollers is engaged and its resistance facilitates the departure from the test stand.

8.5 Closing-down

- Turn the main switch off and secure it with a padlock.

9. Trouble Shooting

9.1 Safety

- If an error message occurs, turn off the test stand and lock the main switch.
- If a warning message occurs, a limited operation is possible.

9.2 Service Address

Sherpa GmbH
D-84453 Mühldorf
Tel.: +49 (0) 8631 3766-0
Fax: +49 (0) 8631 161650
Email: info@sherpa.de
WWW: <http://www.sherpa.de>

9.3 Location and identification of fuses

- The power supply must be fuse-protected on site.
- The electronics is fuse-protected in the control box.

Microfuses:

5A 5A 0.5A 5A
F1 F2 F3 F4

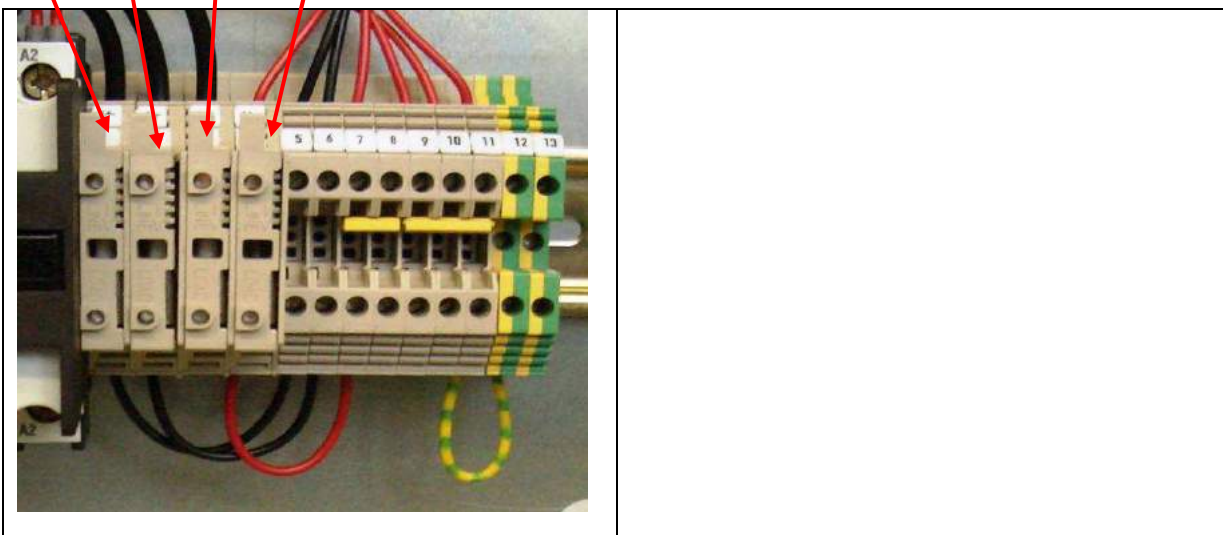

9.4 Error type detection

9.4.1 Error message

- The green LED goes out, the orange LED flashes
- The right needle display indicates the error number
- On the digital computer display the error code appears in a red error field.

9.4.2 Warning message

- The green LED flashes, the orange LED goes out.
- The right needle display indicates the warning number.
- On the digital computer display the error code appears in a yellow error field.

9.5 Error checklist

9.5.1 Initial fault clearance activities

Error

(No operation of the test stand is possible. Use the automatic button to “zip” through the errors).

Cause	Illustration (scale 0-40))	Remedy
Possible cause(s)	Fault / Error message	Corrective Actions
no power supply	no LED lights up	check the fuse of the power supply
insufficient power supply	test stand does not perform unusual sound coming from the engine	check the fuse of the power supply
failure on bus connection malfunction of a bus user	all LEDs are flashing (master display) all LEDs are lit up (simultaneous display)	no operation possible check the fuse in the control box please contact us on our service address
braking force sensor left – line break	orange LED flashes right pointer – 1	check the cabling
braking force sensor right – line break	orange LED flashes right pointer – 2	check the cabling
slip sensor roll left – line break	orange LED flashes right pointer – 3	check the cabling
slip sensor roll right – line break	orange LED flashes right pointer – 4	check the cabling
sensor left – line break	orange LED flashes right pointer – 5	check the cabling
sensor right – line break	orange LED flashes right pointer – 6	check the cabling
braking force sensor left or slip sensor roll left – increased defect	orange LED flashes right pointer – 7	replace the sensor
braking force sensor right or slip sensor roll right – increased defect	orange LED flashes right pointer – 8	replace the sensor
sensor left – increased defect	orange LED flashes right pointer – 9	replace the sensor
sensor right – increased defect	orange LED flashes right pointer – 10	replace the sensor
slip sensor engine left – line break	orange LED flashes right pointer – 11	check the cabling
slip sensor engine right – line break	orange LED flashes right pointer – 12	check the cabling
slip sensor engine left –	orange LED flashes	replace the sensor

increased defect	right pointer – 13	
slip sensor engine right – increased defect	orange LED flashes right pointer – 14	replace the sensor
distance sensor left – line break	orange LED flashes right pointer – 15	check the cabling
distance sensor right – line break	orange LED flashes right pointer – 16	check the cabling
distance sensor left – point zero too small/high	orange LED flashes right pointer – 18	check the sensor adjustment
distance sensor right – point zero too small/high	orange LED flashes right pointer – 19	check the sensor adjustment
sideslip sensor for wheel alignment – line break	orange LED flashes right pointer – 20	check the cabling
sideslip sensor for wheel alignment – point zero too small/high	orange LED flashes right pointer – 21	check the sensor adjustment

Warnings

(A limited operation via the automatic button is possible after the warning has occurred)

Cause	Illustration (scale 0-40)	Remedy
Possible cause(s)	Fault / Error message	Corrective Actions
The wheels of the vehicle rest between the set of rollers when the test stand is started.	Automatic mode cannot be switched on - after pushing the button the test stand will start in manual mode.	Drive the vehicle off the set of rollers (Automatic auxiliary drive-off system if main switch is switched on)
braking force sensor left - point zero too high	green LED flashes left pointer – 1	limited measuring range
braking force sensor right - point zero too high	green LED flashes left pointer - 2	limited measuring range

10. Maintenance and Repair

10.1 Safety

10.1.1 Safety check

- The operator must inspect all safety-relevant devices of the test unit at least once a year. (Regulations of the German trade associations BGV A1, §39 Abs. 1 and 3)

10.2 Proof of Maintenance

10.2.1 Maintenance

- see maintenance plan for the test unit
- any repair work may only be carried out by authorized service personnel

10.3 Control Process and Testing Devices

10.3.1 Routine test

- The routine test must be carried out by an authorized service technician before the first commissioning of the test unit.
- It must be repeated every 2 years.
- The routine test must be carried out after the test unit has been repaired, if relevant components were replaced for the measurement.
- Before the defects are remedied the test stand must not be used for braking tests in accordance with §29 StVZO and appendix VIII StVZO in connection with §41 StVZO.
- Another routine test must be carried out within 4 weeks after a successful repair.
- The date for the next routine test must be indicated on an inspection tag clearly visible at an appropriate spot at the test stand.

10.3.2 Special tools, equipment, materials in accordance with ISO 17025

- mechanical calibration devices for test stands and pedal force meters
- electronic calibration devices for test stands and pressure gauges
- calibration manuals
- routine test document with inspection tag
- test book with test report

10.4 Inspection and Maintenance Plan

d = daily, w = weekly, m = monthly, y = annually				
Work to be carried out	d	w	m	y
Optical inspection before use				
Cleaning and lubrication depends on the service and the external conditions				
Inspection and maintenance work			every 6	
Routine test with inspection and maintenance work				every 2

10.5 Specification of the Inspection and Maintenance Work

- Both drive chains need to be checked for the correct tension (a tolerance of 5 mm at the longest part) and sufficient lubrication (customary chain grease) and, if necessary, tensioned (for about 10 mm at the longest part) or lubricated.
- Sweep or vacuum any impurities (e.g. stone, dust) off the set of rolls (do not use any high-pressure cleaner) in order to ensure a smooth operation.
- Particular care must be taken to ensure that the water can run off freely and the water outlet cannot get blocked-up.
- lubricate hinges and joints
- description of the maintenance and repair works
- Repair works may only be carried out by authorized service personnel.

11. Disassembly and Disposal

11.1 Safety

11.1.1 Essential Safety Guidelines

- The power line for the power supply must be disconnected by qualified personnel.

11.1.2 Description of disassembly work

- Remove all line connections between the roller set, the control box and the display units.
- Unscrew the control box and the display units.
- Loosen and remove the foundation adjusting screws from the roller set.
- Screw the eyebolt on top of the roller set, hook the carriage straps into the ring and pull the roller set out of the foundation with the help of a lifting equipment.

11.2 Disassembly

11.2.1 Essential Safety Guidelines

- use a lifting equipment with sufficient lifting capacity

11.3 Description of Disposal Work

11.3.1 Overview

- Legal regulations must be taken into account at the time of the disposal.

11.3.2 Description

- The transmissions of the driving engines are filled with oil which must be disposed of separately.
- Electronic circuit boards must be disposed of separately.
- This also applies for remote controls and printers.
- Sheet metal and iron parts are scrap metal.

12. Complementary Documents

12.1 Drawings and Layouts

- Available on request.

12.2 Foundation and Installation Plans

- Available on request.

12.3 Spare Parts and Consumables

- Available on request.

12.4 Electrical Documentation

- Available on request.

12.5 Operating Manuals for the options

- remote control, computer program „SherlanePC“, brake pressure gauge, and load simulation are available on request.

12.6 Test Reports

- Available on request.

12.7 Service Address

Sherpa GmbH
D-84453 Mühldorf
Tel.: +49 (0) 8631 3766-0
Fax: +49 (0) 8631 161650
Email: info@sherpa.de
WWW: <http://www.sherpa.de>

13. EC Declaration of Conformity

We hereby declare that our test equipment, by virtue of its design and construction and in the configuration placed on the market by us, conforms to the applicable essential health and safety requirements of the relevant EC Directives.

Sherpa Autodiagnostik GmbH
Am Industriepark 11
D-84453 Mühldorf

Tel.: 0049 (0)8631/3766-0
Fax. 0049 (0)08631/161650
www.sherpa.de

Machine Description: Brake Tester
Type: BPS-Kompakt
Version 3.0 to 6.0

Machine No.: _____

EC Machinery Directive: 2006 / 42 / EC of May 17, 2006
EMC Directive: 2004/1 08 / EC of December 15, 2004
Directive on Electrical Equipment: 2006 / 95 / EC of December 12, 2006
Certified tests BPS-3.0: Tüv Nord Certificate BP 202.1, date: 28.05.2010
BPS-3.5 / 6.0: "Tüv Nord Certificate BP 202.2, date: 20.12.2011,
über die Prüfung eines Bremsenprüfstandes"

In the event of modifications of the machine not approved by us this certificate loses its validity.

Mühldorf, 2011



Helmut Lachmann
Executive Director

14. Notes